

PHOTONICS

Technical applications of light
INFOGRAPHICS

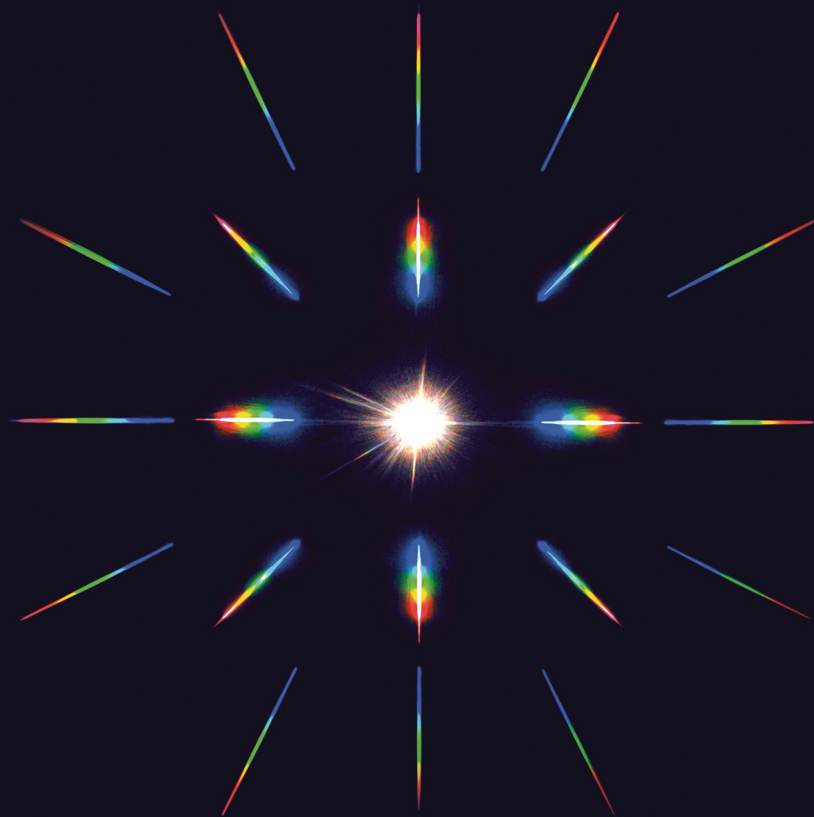

A very warm thank you to all the companies and institutes
that made this publication possible:

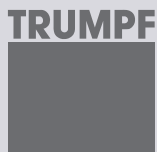

PHOTONICS

Technical applications of light
INFOGRAPHICS

CONTENTS

BASICS

What is photonics?	01
Smallest points	02
Highest velocity	03
Shortest times	04
Highest power	05
Undisturbed superposition	06
Light spectrum	07
Hidden realm of photonics	08
Shorter wavelengths	09
Window glass vs optical fiber	10
Mirrors vs laser mirrors	11
Laser types	12
Laser vs the Sun	13

PRODUCTION TECHNOLOGY

Image of smallest structures	14
Precise laser drilling	15
Laser cutting	16
Smartphones thanks to the laser	17
3D printing	18

DATA TRANSFER

Optical fiber networks	19
Laser communication in space	20
QR-codes	21

IMAGE CAPTURE & DISPLAY

Camera lenses	22
Gesture control	23
Flat screens	24
LCD vs OLED	25

MEDICAL TECHNOLOGY

Counting blood cells	26
Endoscopy	27
Seeing near and far	28
Seeing clearly again	29

LIGHTING

White LED light	30
Brighter with LEDs	31
Lamp specifications	32
Intelligent luminaires	33
Laser shows	34

TRAFFIC

Traffic enforcement	35
Light on and in the car	36
Car headlights	37
Airport lighting	38

PHOTOVOLTAICS

Solar cells	39
Solar energy	40

ENVIRONMENT

Optical measurements in citizen projects	41
Forest fire surveillance	42
Optical sorting	43

RESEARCH & ECONOMY

Photonics as an industry sector	44
Photonics around the globe	45
Nobel laureates	46
Photonics countries	47
Photonics schools	48
Economic impact of photonics	49

+1

Photonics enthusiast	50
----------------------------	----

BASICS

WHAT IS PHOTONICS?

Photonics is the generation, transmission, and utilization of light and other electromagnetic radiation. Photonics offers solutions to the global challenges of our time.



generation



transmission



utilization

FUTURE POTENTIAL
HEALTH
COMMUNICATION
INFORMATION
MOBILITY
ENERGY
SECURITY
CLIMATE
SUSTAINABILITY

SMALLEST POINTS

Light can be focused on extremely small diameters.

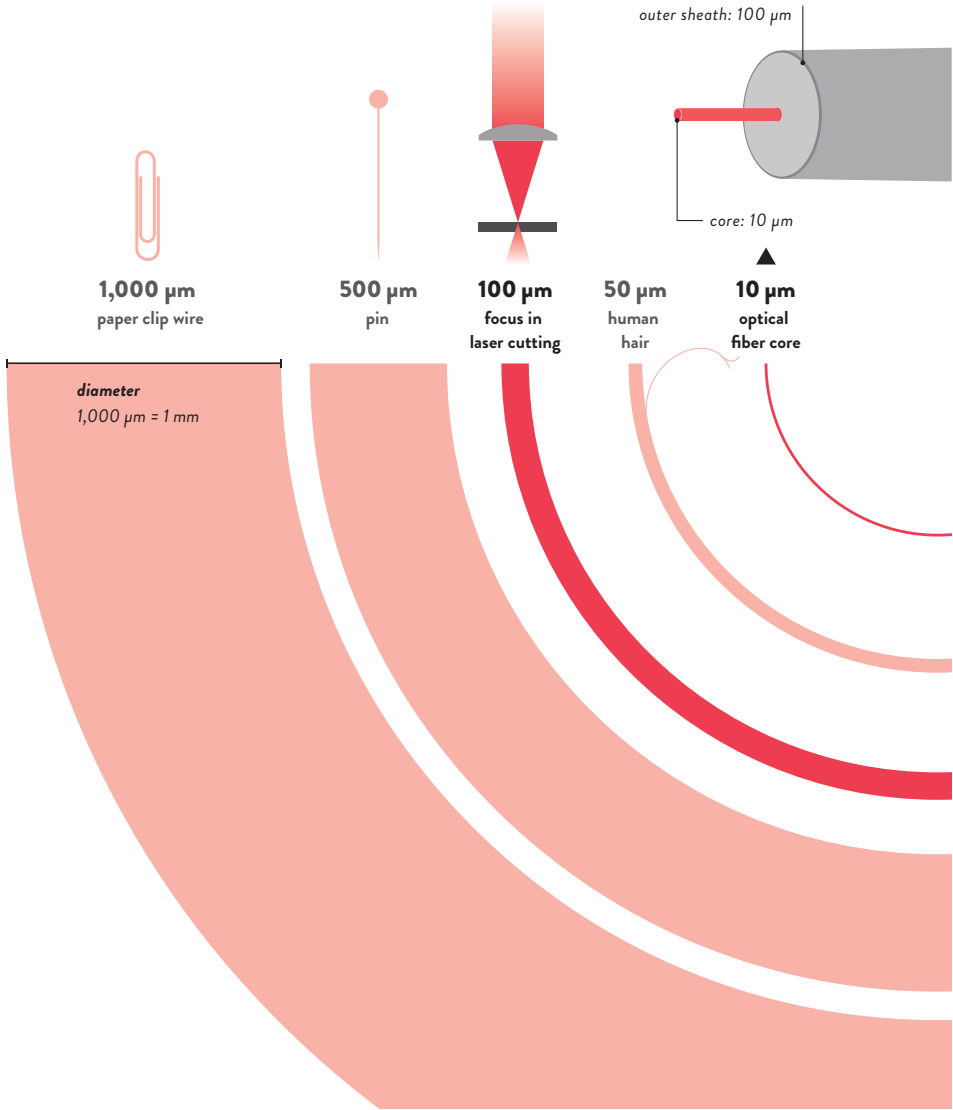

HIGHEST VELOCITY

Nothing is faster than light.
The speed of light is 299,792,458 m/s.

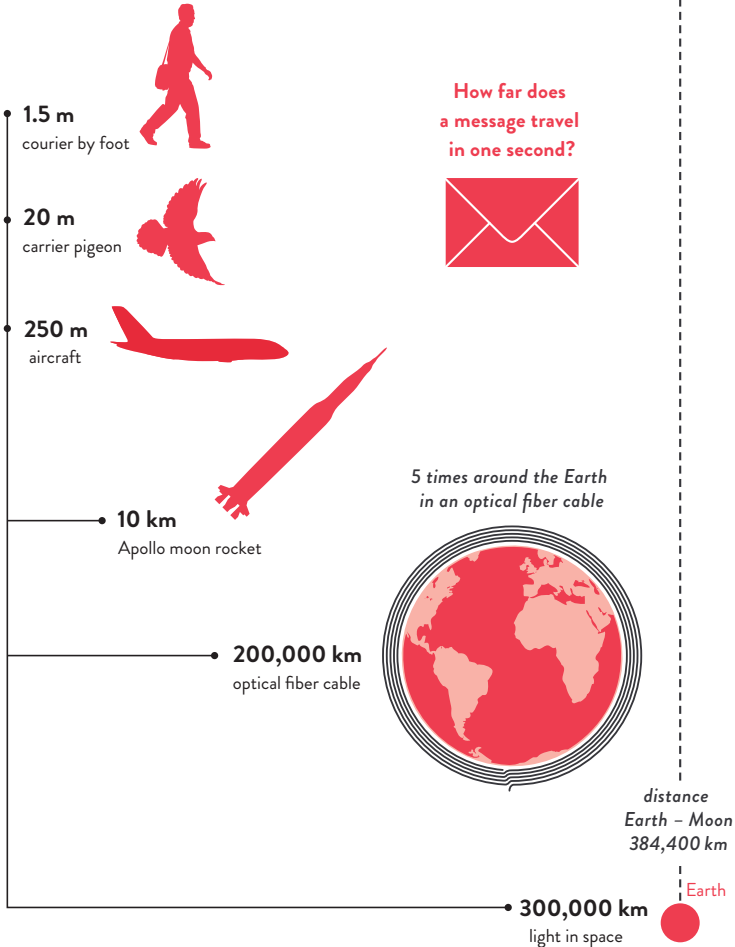

SHORTEST TIMES

Light makes even the fastest events measurable.

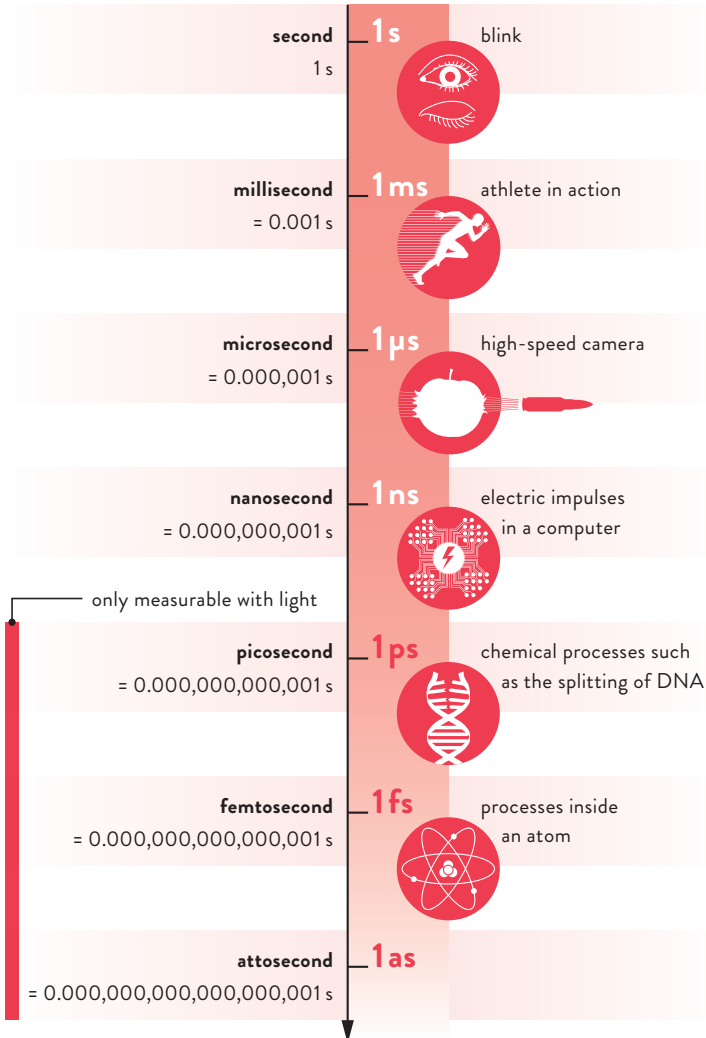

05

HIGHEST POWER

With the pulsed operation of lasers, a power orders of magnitude greater than anything we have known so far can be achieved.

This is made possible through the concentration of laser power to very short femtosecond pulses.

COMPARISON OF POWER



Worldwide power generated
by electric power plants

2.6 terawatts = 2,600 gigawatts

around 400 times

1 petawatt

Generated power of the
Berkeley Lab Laser Accelerator

1 petawatt

= 1,000,000 gigawatts

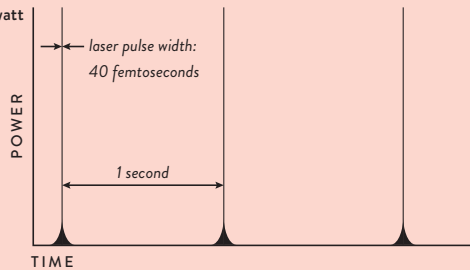

*Peak powers are reached periodically
for very short time intervals.*

UNDISTURBED SUPER- POSITION

Dozens of data signals can be coupled into one single optical fiber and be separated again at the receiver's end. The signals can be very finely distinguished based on their wavelength (spectral color), polarization, and phase.

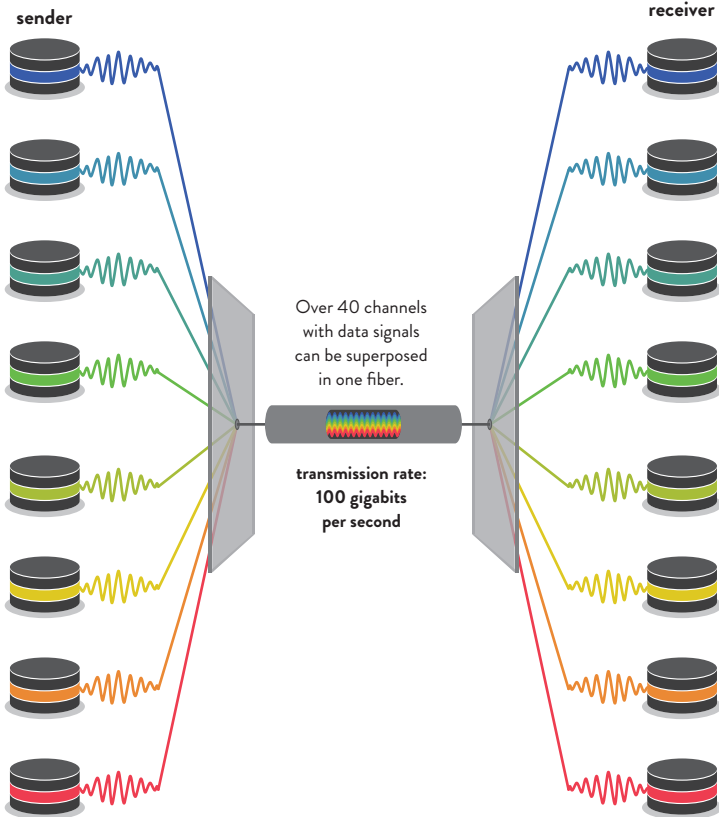

LIGHT SPECTRUM

Light is the very small part of the electromagnetic spectrum visible to the human eye in the wavelength range of 380 to 780 nanometers.

SPECTRAL SENSITIVITY OF THE EYE AT DAYTIME

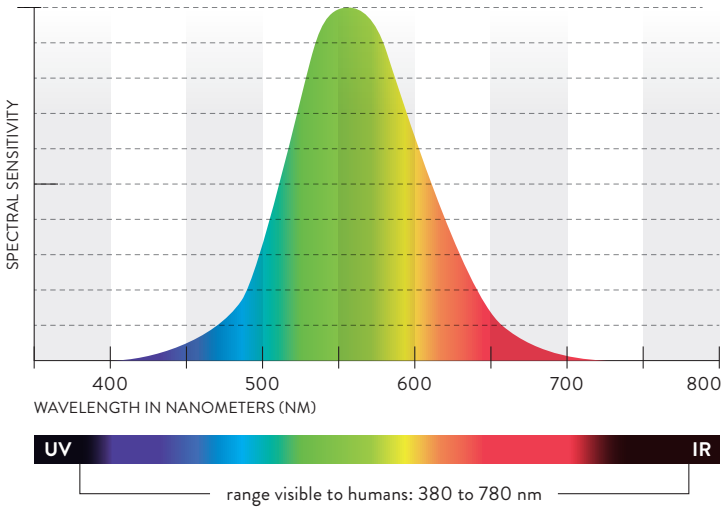

SPECTRAL DISTRIBUTION OF SUNLIGHT ON EARTH

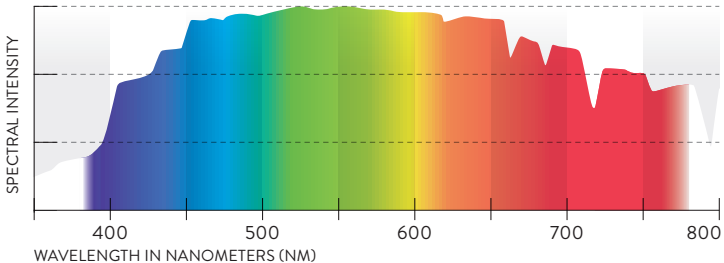

HIDDEN REALM OF PHOTONICS

Photonic applications use a broad portion of the electromagnetic spectrum that is predominantly not visible to humans.

NUCLEAR TECHNOLOGY

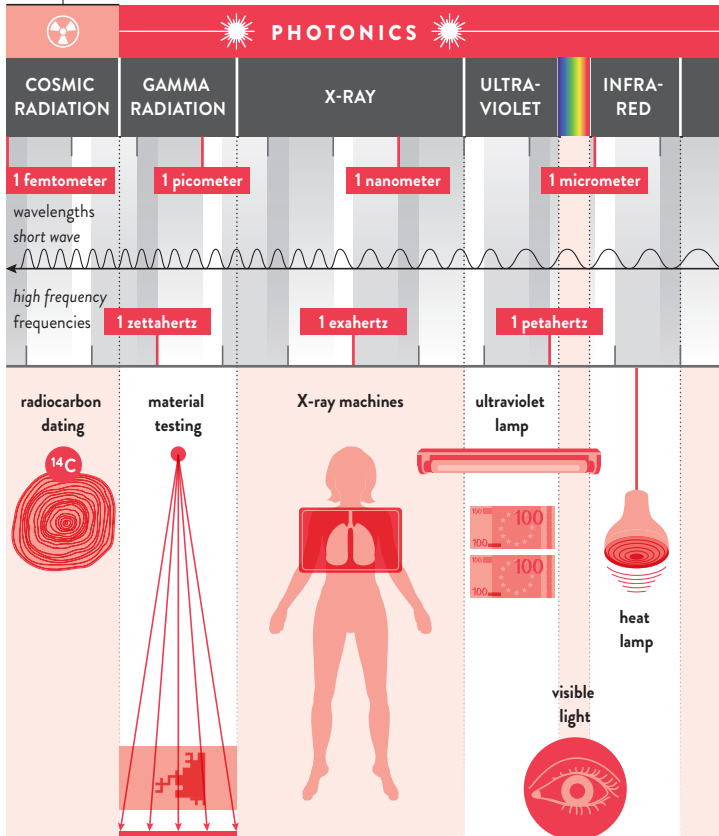

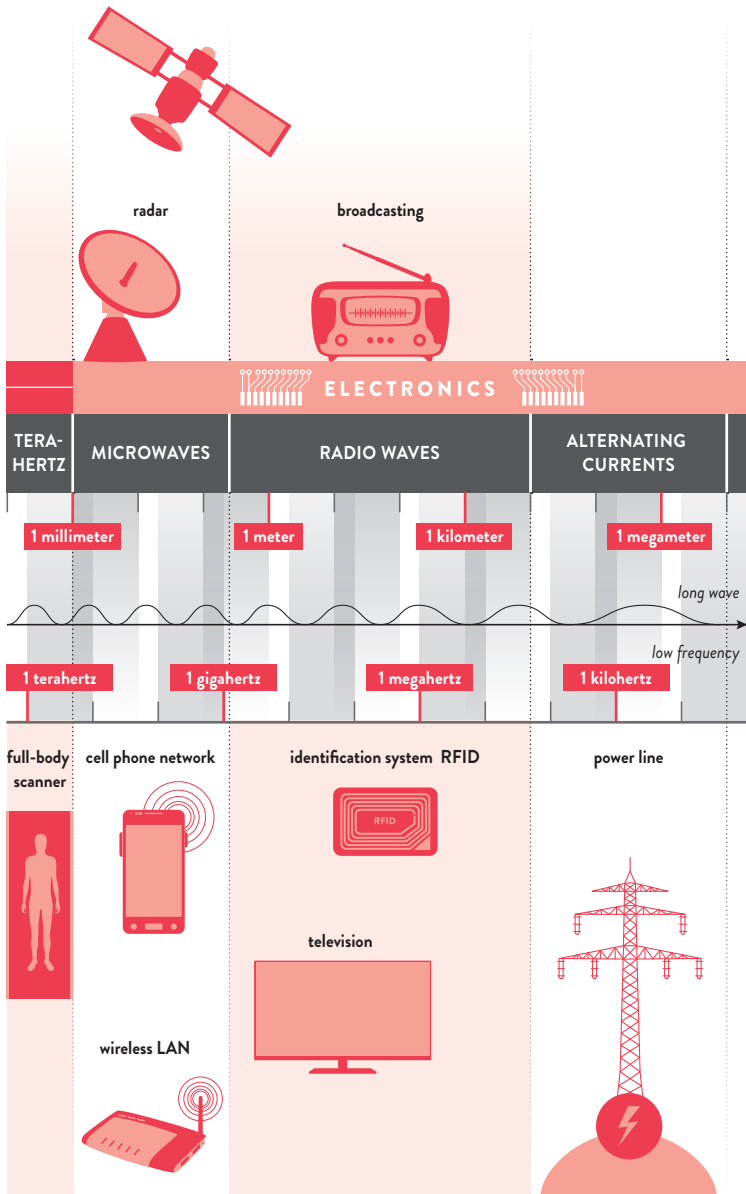

SHORTER WAVELENGTHS

Wavelength has a great influence on the performance of optical systems. Shorter wavelengths can produce smaller focus diameters making greater recording densities possible on optical storage media.

WAVELENGTHS USED TO READ OPTICAL DISCS

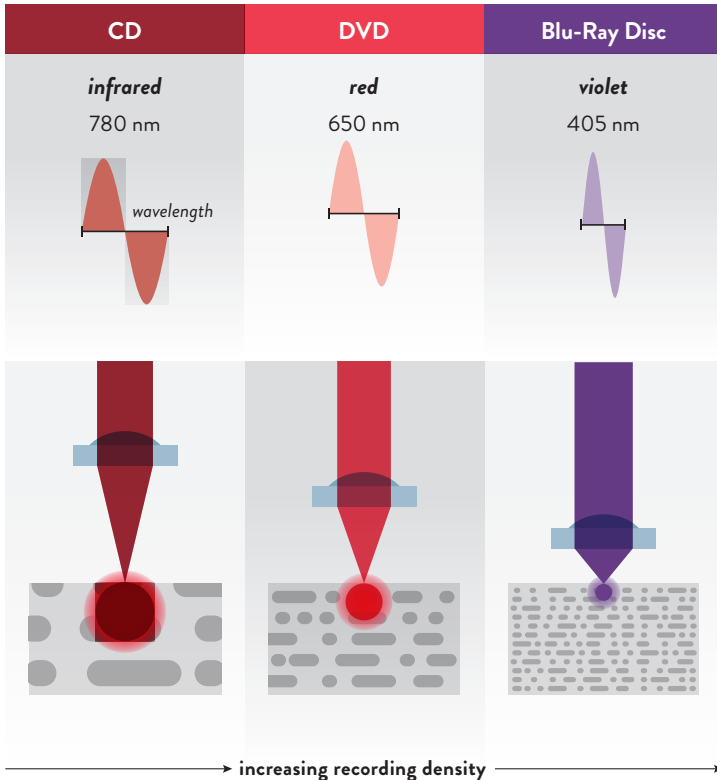

WINDOW GLASS vs OPTICAL FIBER

Glass is the most important component of optical systems. However, common window glass and glass used in photonics applications are worlds apart.

LIGHT TRANSMISSION OF GLASS

How thick can different glass types be so that 1% of the emitted light is still transmitted?

WINDOW GLASS

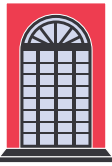

glass thickness

80 cm

1%
of light

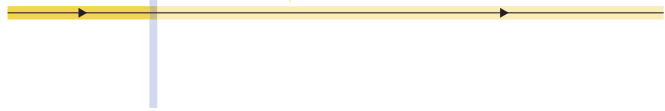

OPTICAL GLASS



(example: camera lens)

29 m

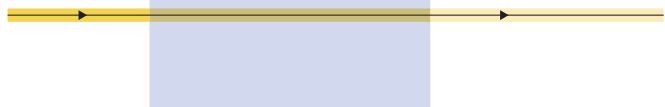

OPTICAL FIBER



100 km (only valid for infrared light)

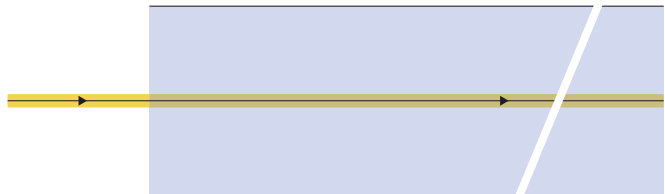

MIRRORS vs LASER MIRRORS

Many optical components can be found
in their basic forms in the home.

The components used in photonics,
however, are characterized by the
highest accuracy and technical finesse.

HOUSEHOLD MIRROR CONSTRUCTION

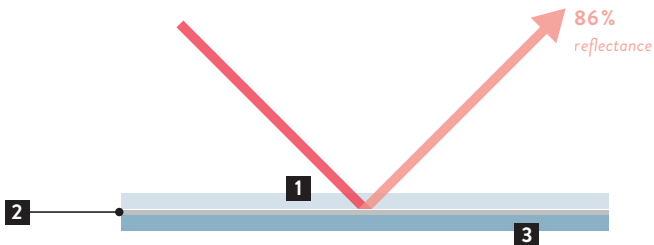

- 1** glass plate
- 2** back silver coating
- 3** protective layer

LASER MIRROR CONSTRUCTION

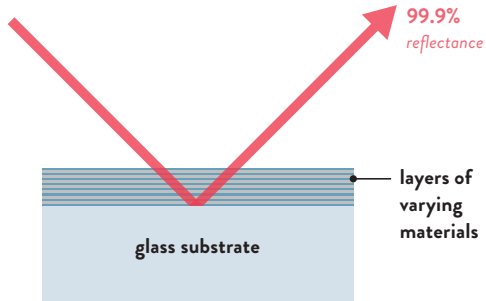

Usually, at least 20 to 50 layers of 100 to 200 nanometers thickness are applied on the front of a substrate. The result is an extremely high reflectance.



LASER TYPES

Lasers are the central component of many photonics applications. The numerous laser types always consist of the same basic elements although their shape strongly varies.

basic elements

- active medium = excited atoms or molecules
- energy supply = pump ■ optical ■ electrical
- resonator (end mirror or output coupler)
- laser beam

DIODE LASER

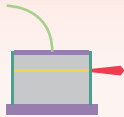

FIBER LASER



DISK LASER

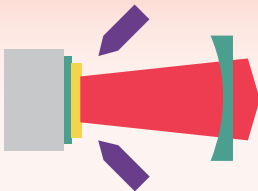

GAS LASER

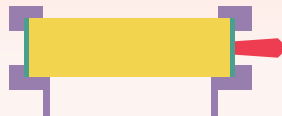

LASERS vs THE SUN

While conventional light sources emit their energy in all directions, lasers bundle the emitted light very efficiently into almost parallel light beams of small diameters.

PERFORMANCE COMPARISON

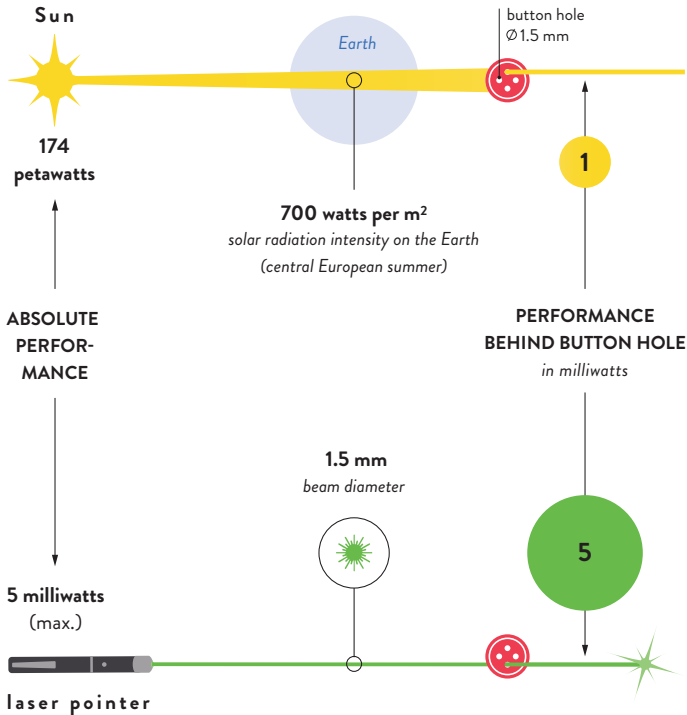



PRODUCTION
TECHNOLOGY

IMAGE OF SMALLEST STRUCTURES

Modern technology requires efficient electronics in the smallest spaces. Thanks to optical technologies it is possible to organize increasingly smaller electronic components on semiconductor chips.

DEVELOPMENT OF SEMICONDUCTOR PRODUCTION PROCESSES

The image of increasingly smaller structures requires light sources with very short wavelengths.

OPTICAL BEAM PATH

Extreme ultraviolet (EUV) light, which is already in use and which has a wavelength of only 13.5 nanometers, requires the application of purely reflective optics with extremely accurate geometry.

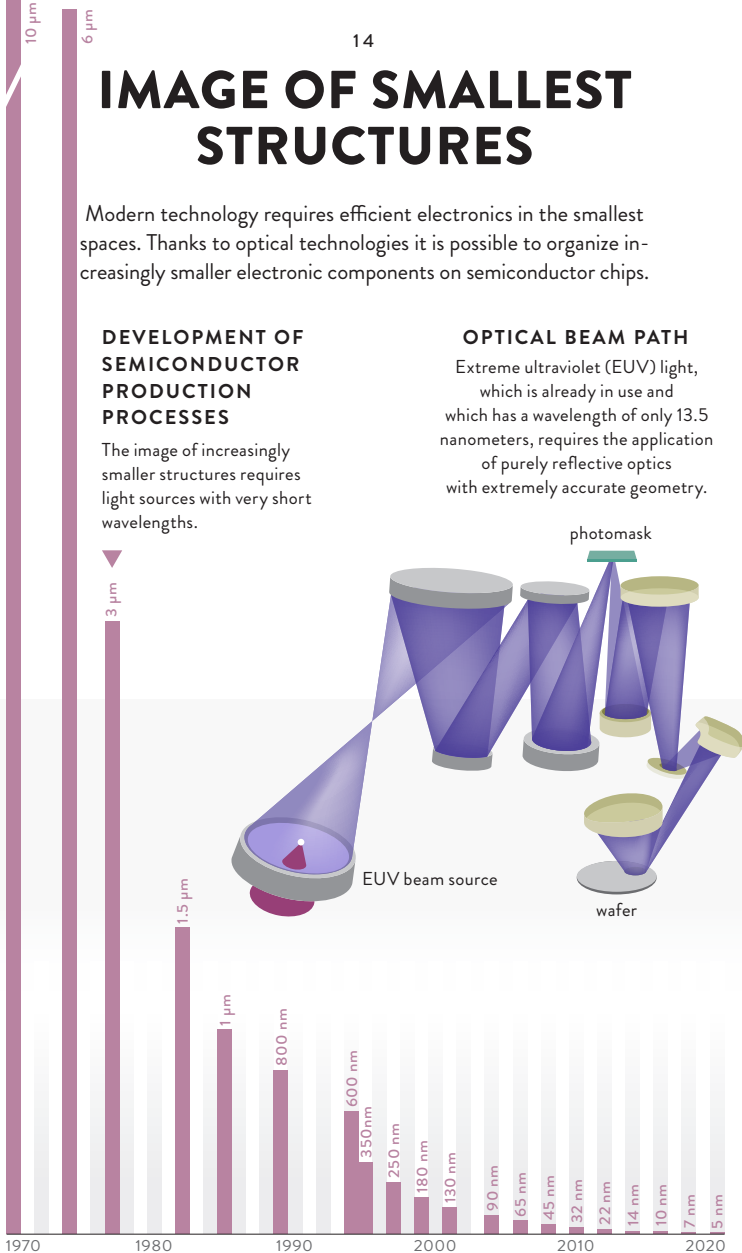

PRECISE LASER DRILLING

Ultrashort pulse lasers drill differently sized, accurately shaped injection nozzles that distribute the fuel in the best way possible. Thanks to laser precision machining, up to 30% of fuel can be saved.

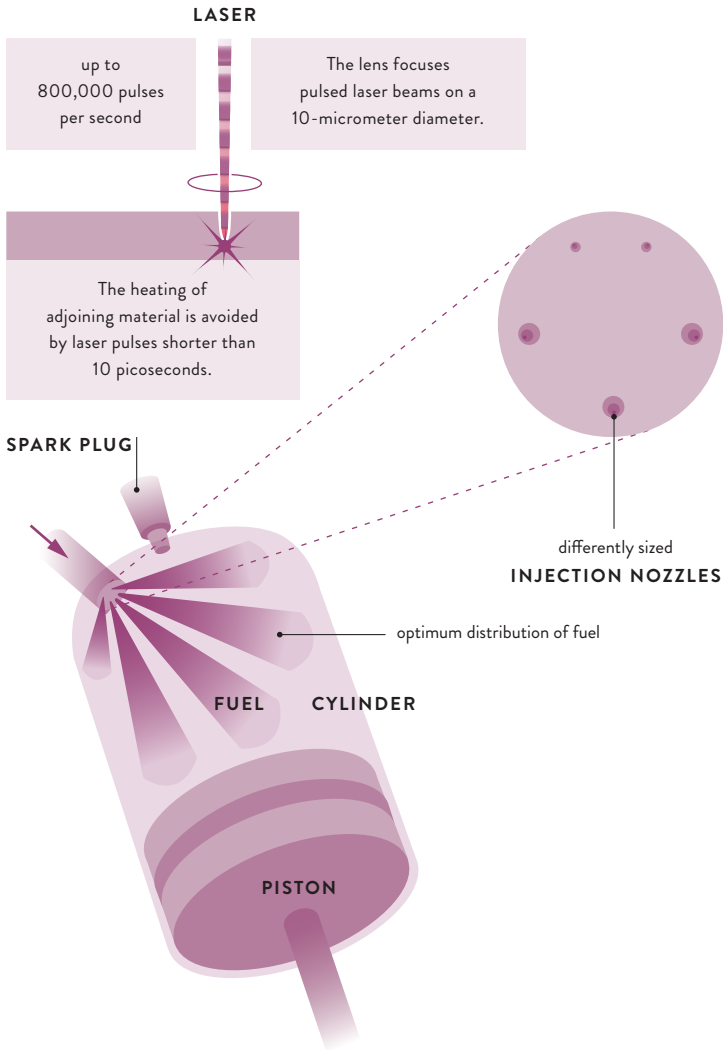

LASER CUTTING

Laser cutting enables very quick processing of materials with a low loss of material, which makes this method extremely energy-efficient.

EFFICIENCY AND PERFORMANCE COMPARISON OF CONVENTIONAL MILLING AND LASER CUTTING

cutting a 5-millimeter-thick steel plate
for one meter

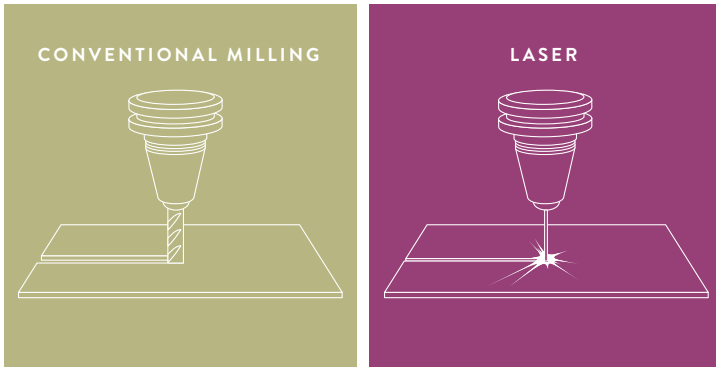

CUTTING WIDTH

(millimeters)

10

0.4



TOOL PERFORMANCE

(kilowatts)

0.4



20

DURATION

14 Minutes

PER METER

12 Seconds

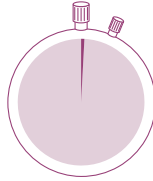

ENERGY CONSUMPTION

(kilowatt hours)

0.10



0.07



WASTE

(grams)



390



15

TOTAL ENERGY CONSUMPTION

taking into account material savings

(kilowatt hours)

2.05

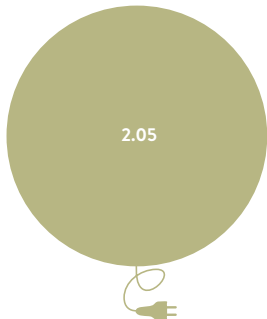

0.14



SMARTPHONES THANKS TO THE LASER

Hundreds of thousands of smartphones are manufactured daily. Quality and efficiency of production are of crucial importance to the manufacturers in this competitive market. Lasers are the key to success here.

LASER TYPES

- fiber laser
- UV solid-state laser
- solid-state laser
- CO₂ laser
- ultrashort pulse laser
- UV excimer laser
- IR diode laser

MACHINE PROCESS

- / edge
- - - pattern
- area
- . . . holes

Touchscreen

- cutting of extremely thin, hard cover glass /
- cutting of touchscreen foil /
- structuring of conducting layers - - -

Screen

- generation of polycrystalline layers
- encapsulation of laminated glasses /

Battery

- welding of battery case /
- marking logo, data-matrix-code, and serial number

Circuit board

- structuring of conductor tracks - - -
- cutting of foil circuit boards /
- drilling of contact holes . . .

Housing

- cutting of housing - - -
- marking logo and serial number /

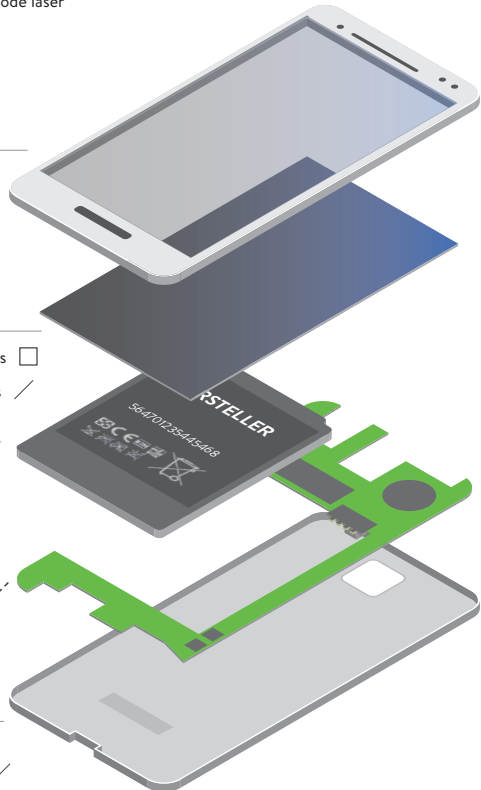

3D PRINTING

Based on a computer drawing, complex structures can be produced from plastics, ceramics, and metals with the help of selective laser melting. Dentures and implants are among the rapidly growing number of applications.

GENERAL OPERATING PRINCIPLE

The digital model of an object is transformed into a model made of a series of thin layers.

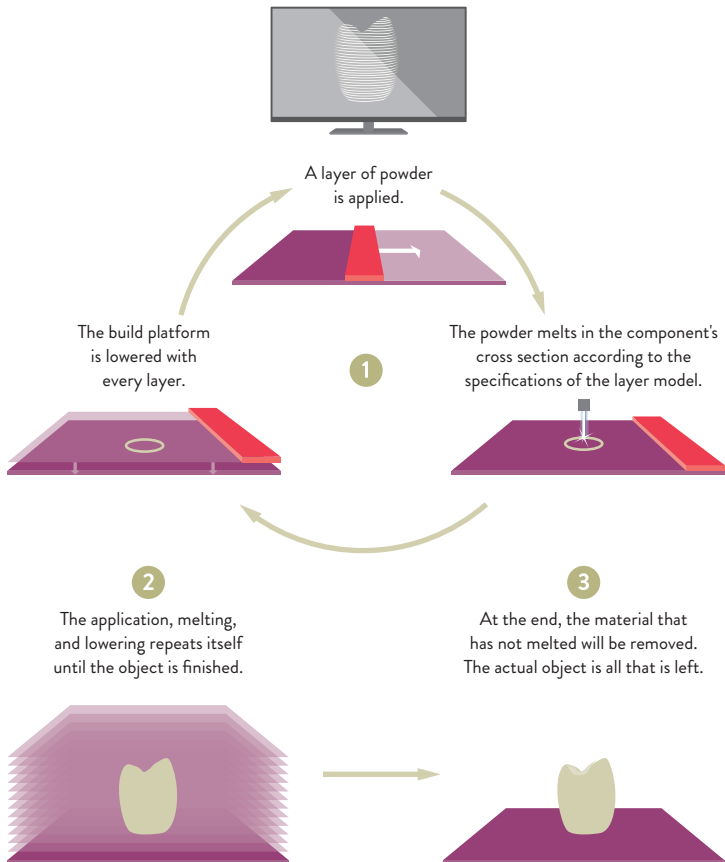

The background is a solid dark purple color. Overlaid on this are several large, overlapping geometric shapes in lighter shades of purple. One prominent shape is a large, light purple triangle pointing downwards, with its top vertex near the top center. Another shape is a darker purple triangle pointing upwards, with its bottom vertex near the bottom center. These shapes overlap to create a complex, layered effect. The text 'DATA TRANSFER' is centered horizontally and vertically within the composition.

DATA TRANSFER

OPTICAL FIBER NETWORKS

In 1988, the first transatlantic optical fiber cable, the TAT-8, went into operation. Optical fiber quickly replaced copper cables to meet the fast-growing need for greater capacity. Today, submarine cables with capacities of up to several terabytes per second connect the whole Earth.

Optical fibers offer substantially higher transmission rates, while simultaneously providing large ranges. Other advantages are lighter cables, lower space requirements, and fewer repeaters. The operation and maintenance costs are also significantly reduced.

Data cable in city area

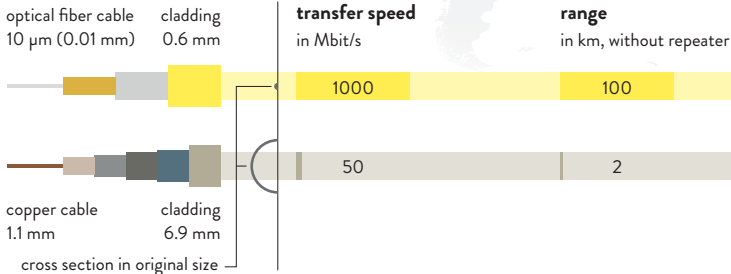

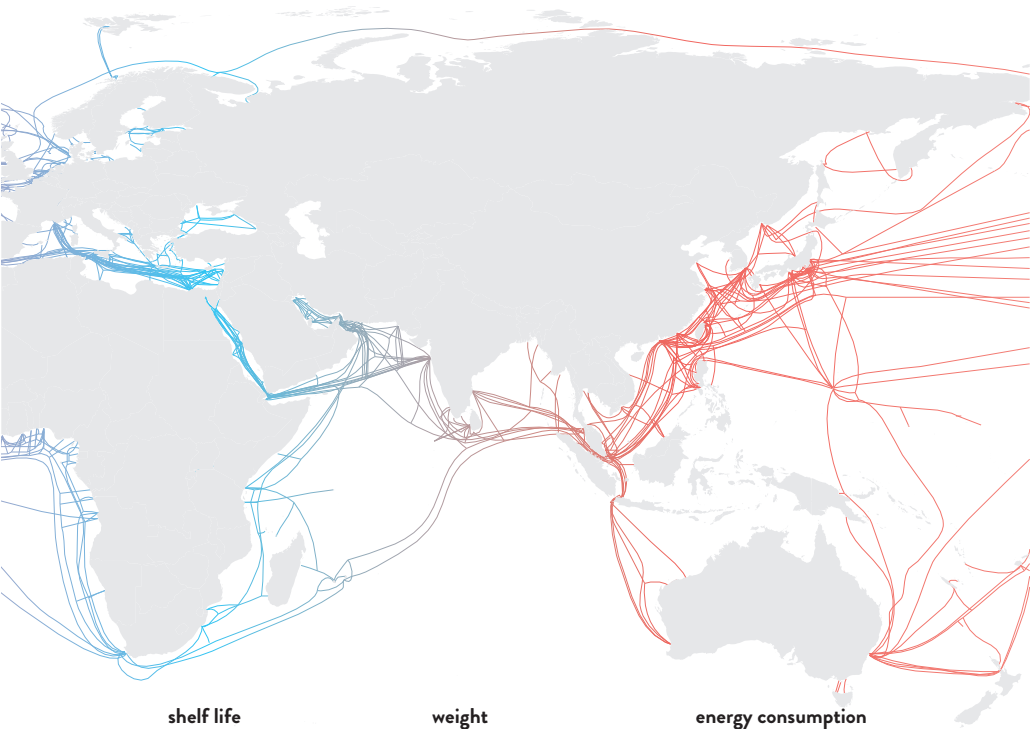

shelf life
in years

50

weight
per 100 m cable in kg

0.6

energy consumption
in watts per user

2

5

5.8

10

LASER COMMUNICATION IN SPACE

Free space optical communication between near-Earth and geostationary satellites enables the fast transfer of data to a ground station.

Vital data during natural catastrophes or in emergencies at sea can be received almost in real time in this way.

ADVANTAGES OF THE LASER

LARGE DATA VOLUMES

1.8
gigabytes per second
corresponds to
around 500 songs
per second

NO LIMIT
due to frequency
allocations



LOWER ENERGY CONSUMPTION
expands
shelf life



LESS MASS
saves costs

THE LASER AND OPTICS MEET THE HIGHEST REQUIREMENTS

SMALLEST TOLERANCE
for generating
a bundled
laser beam
across largest
distances



stable
despite great
TEMPERATURE DIFFERENCES

survive
strong
VIBRATIONS
and
ACCELERATIONS
during rocket launches

over **15** years
MAINTENANCE-FREE



RESISTANT
against UV and
gamma radiation
in space



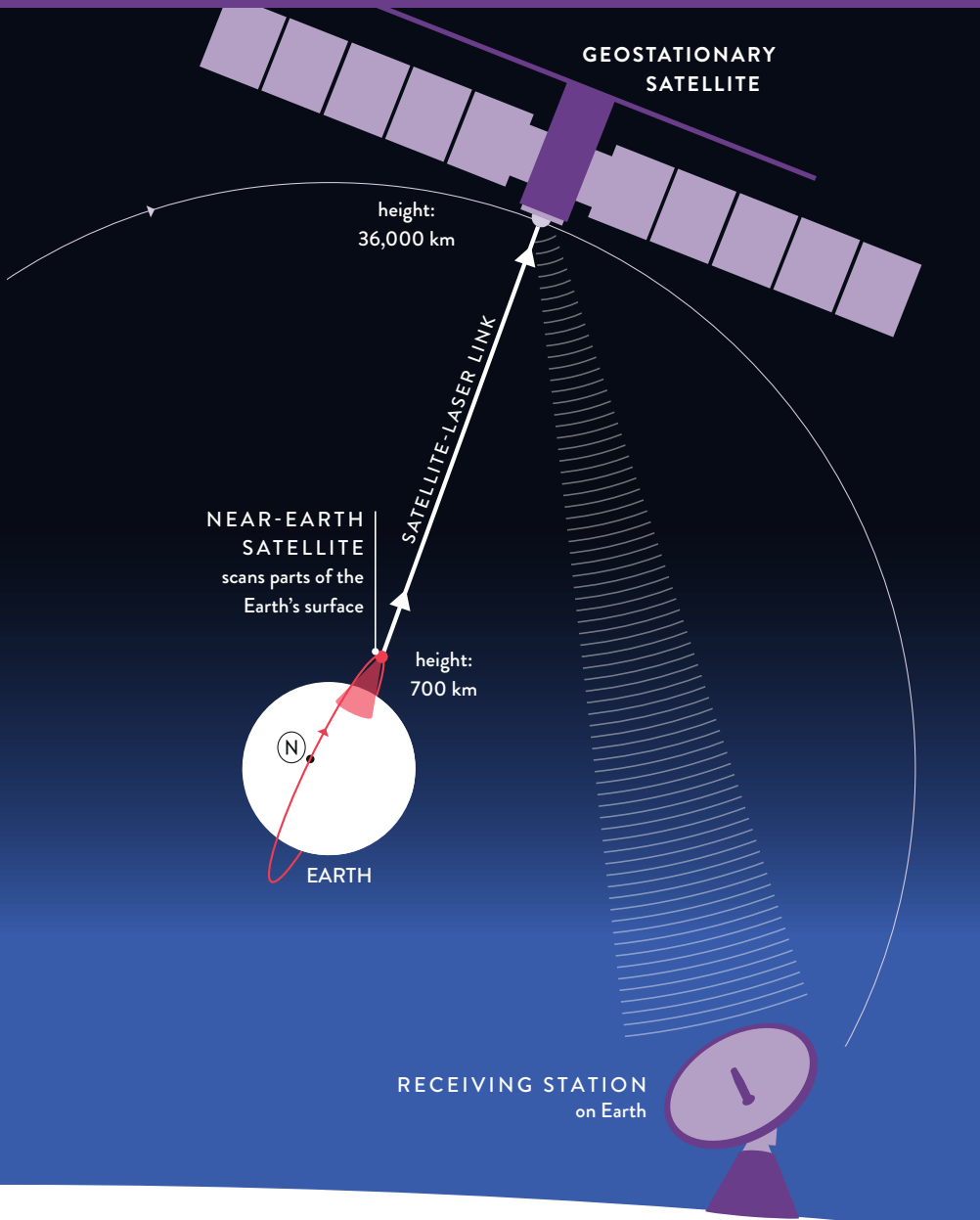

**GEOSTATIONARY
SATELLITE**

height:
36,000 km

SATELLITE-LASER LINK

**NEAR-EARTH
SATELLITE**
scans parts of the
Earth's surface

height:
700 km

EARTH
N

RECEIVING STATION
on Earth

QR CODES

Cameras and optical sensors often work together with intelligent image or data processing. The QR code (Quick Response) shows this impressively.

USE OF QR CODES

QR codes are two-dimensional bar codes. A camera phone with the appropriate code reader software recognizes this information and decodes it.

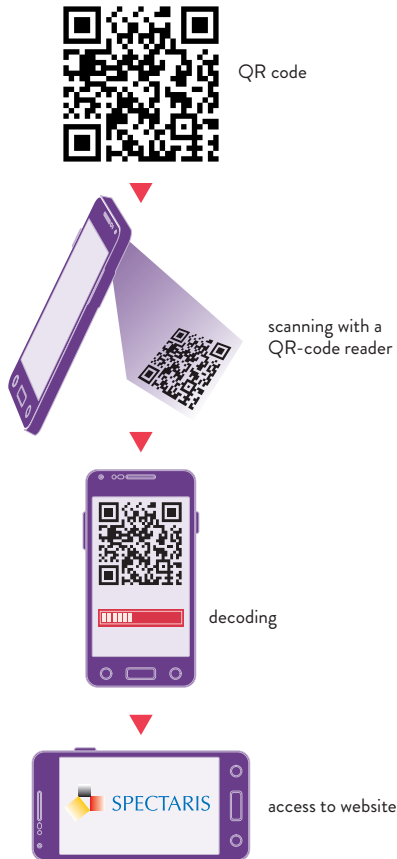

QR-CODE STRUCTURE

Apart from the content, QR codes contain additional elements so that the software can recognize the data correctly.

This includes:

- positioning
- format information
- timing
- version information
- alignment



Up to **4,000** alphanumeric characters fit on a QR code.

ADVANTAGES OF QR CODES

In comparison to the classic barcode, QR codes can store more information on a smaller area and make fewer requirements of reading devices.

They also function even if they are partly damaged or corrupted:



graphic/text in code



distorted



blurred



twisted



IMAGE CAPTURE
& DISPLAY

CAMERA LENSES

Today, brilliant images are possible with the smallest smartphone lenses.

Why then is it still necessary to have large lenses in photography?

SIZE COMPARISON

(original sizes)

SMARTPHONE
LENS



SLR
LENS

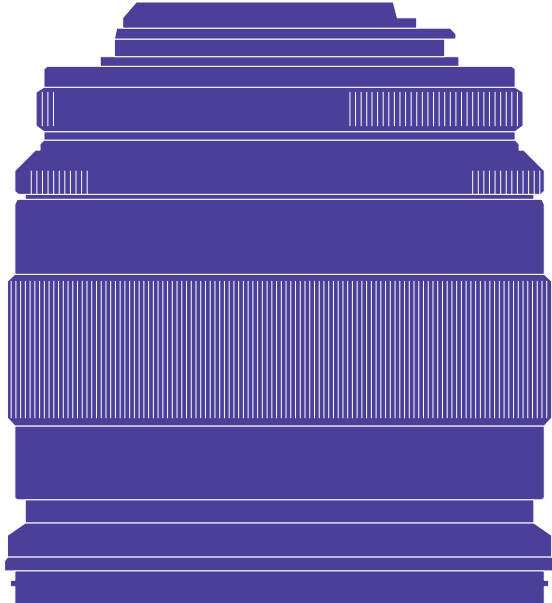

LENS ARRANGEMENT

Despite their small size, smartphone lenses have sophisticated optics with complex lens arrangements.

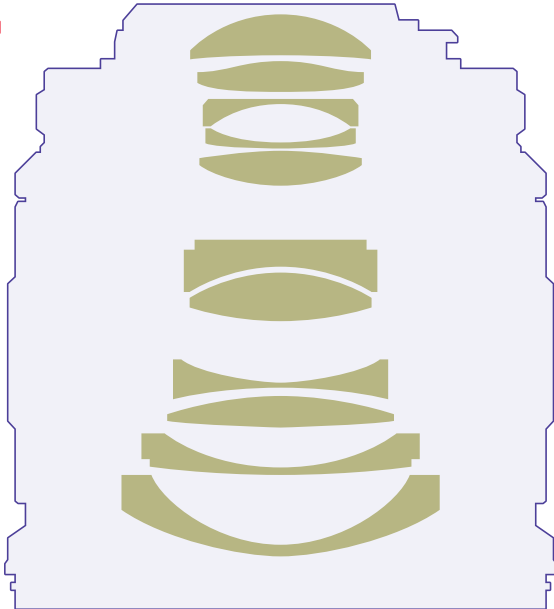

DEPTH OF FIELD

The most important consequence of the size difference is the different depths of field.

SMARTPHONE LENS

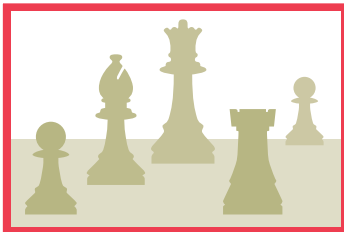

Smartphones display all objects from near to far with the same sharpness.

SLR LENS

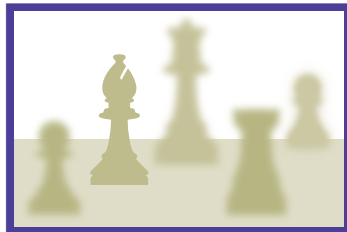

The depth of field can be set selectively with large SLR lenses.

GESTURE CONTROL

Optical systems can capture and interpret hand movements contactlessly – this is ideal in sterile workplaces such as hospital operating rooms.

SURGICAL HAND-TRACKING SYSTEM

detailed view from below

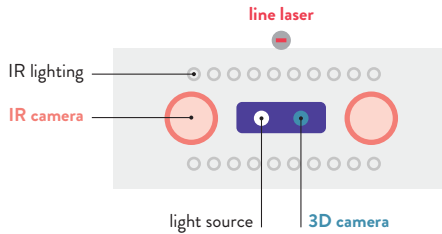

Two **infrared (IR) cameras** capture the scene like two human eyes from slightly shifted perspectives.

A **3D camera**, which is based on the propagation time of light, verifies the distance.

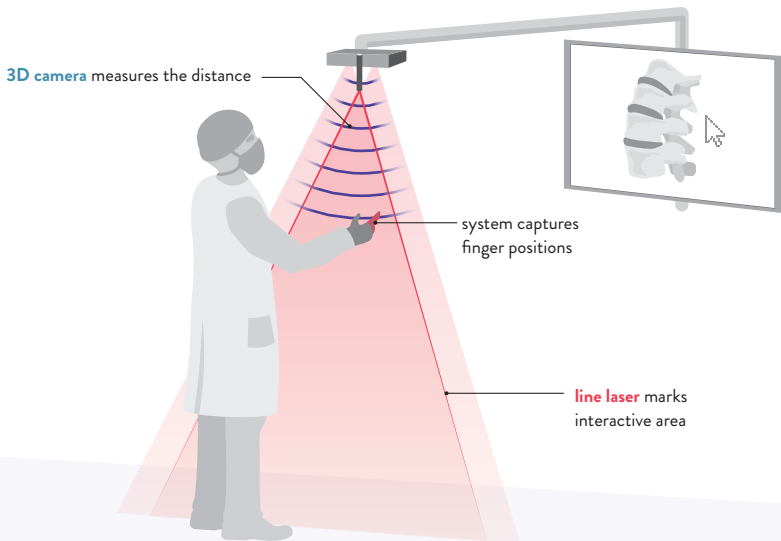

FLAT SCREENS

In contrast to early cathode ray tubes, flat screens save a great deal of energy per unit area. Impressive global production capacities meet the high demand for these displays.

ELECTRICITY CONSUMPTION AT SAME DISPLAY SIZE

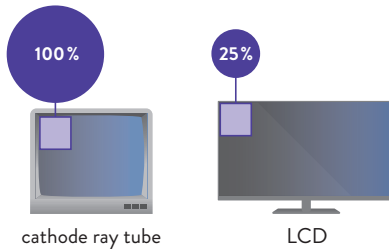

PRODUCTION OF FLATSCREENS WITHIN ONE HOUR

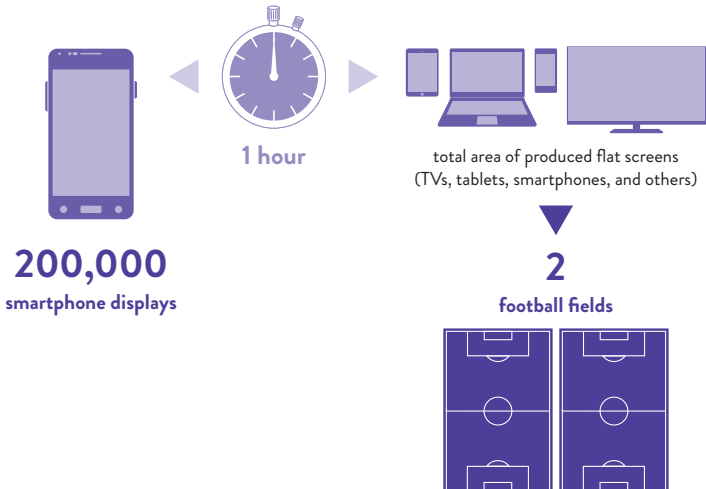

LCD vs OLED

Today, LCD displays dominate the flatscreen market, but in smartphones, organic LEDs (OLEDs) are conquering an increasingly larger market share. OLED displays are thinner, more energy-efficient, and higher in contrast but more expensive to produce.

LCD DISPLAY STRUCTURE

Today's most common type of display creates images by blocking off or letting through white light that LEDs create across the back of the display.

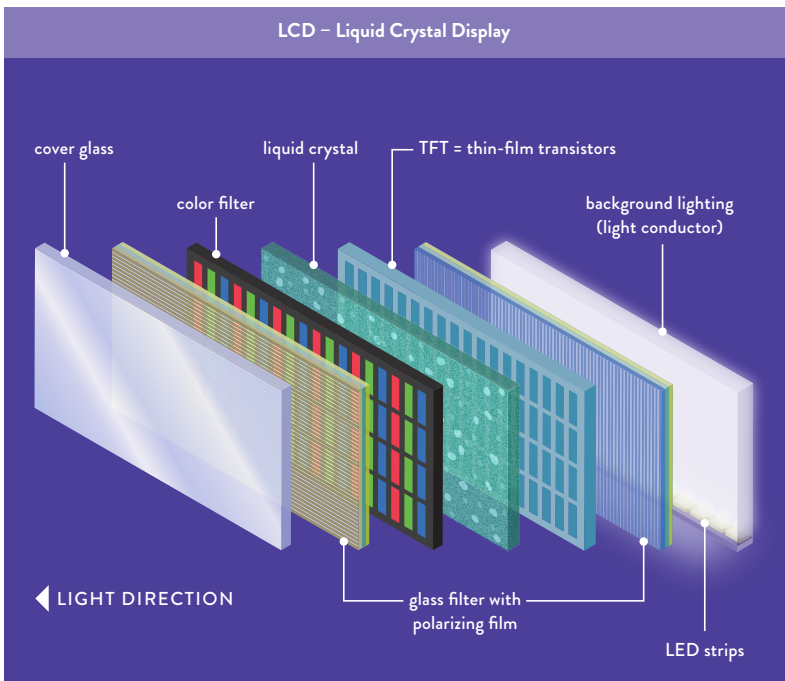

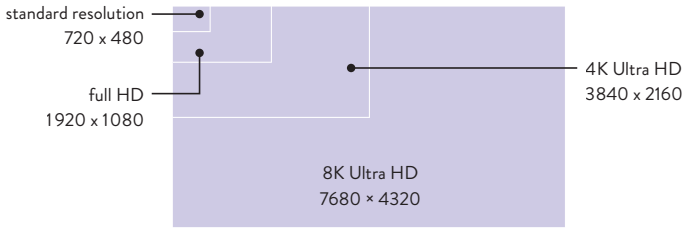

display resolutions
in pixels

OLED DISPLAY STRUCTURE

Organically luminous materials in OLED displays do not require a separate light source, which makes their construction depth much thinner.

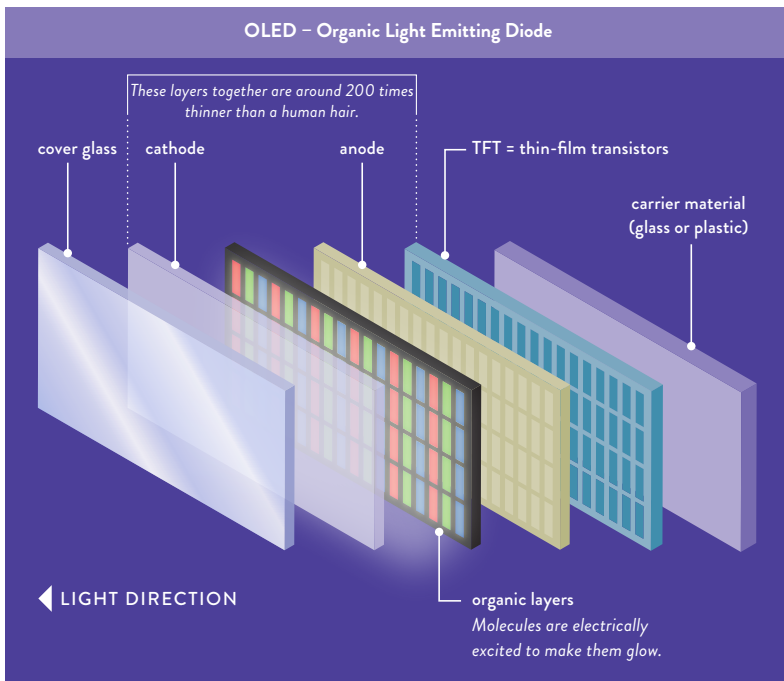



MEDICAL TECHNOLOGY

COUNTING BLOOD CELLS

Thousands of cells per second are counted and characterized in medical and biotechnical analytics with laser-based flow cytometry. This enables the fast and secure detection of blood anomalies.

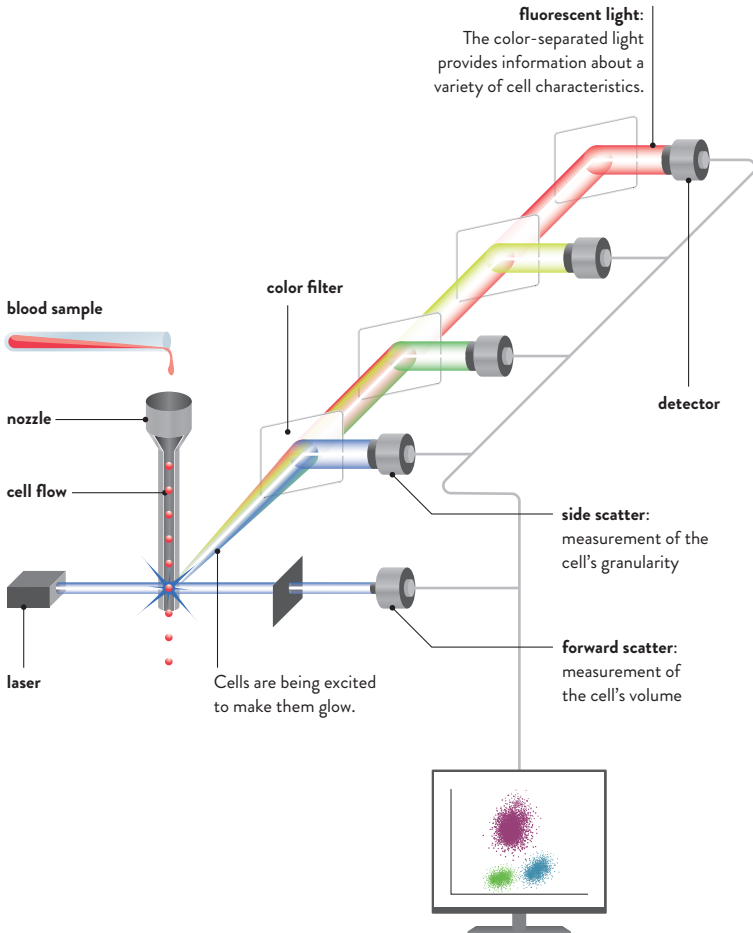

ENDOSCOPY

Endoscopes enable doctors to examine body cavities and hollow organs, detect illnesses, and treat them with minimal invasion at the same time, if required. The tubes, which are only a few millimeters thick, transfer illumination in one direction and high-resolution images in real time in the other direction.

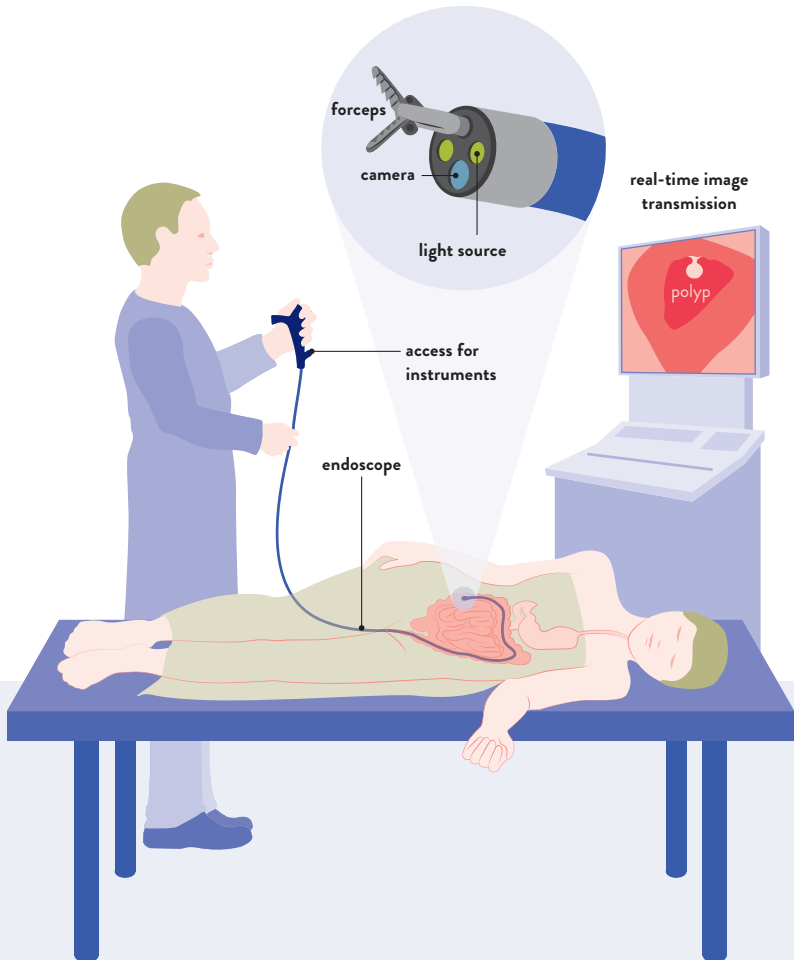

SEEING NEAR AND FAR

Individually adjusted varifocals help older people have good vision for all distances. A variety of criteria is included in the calculation for personalized and individual lens design.

CNC machines are used to translate the calculated design into individual lenses with micrometer precision.

INDIVIDUAL CRITERIA

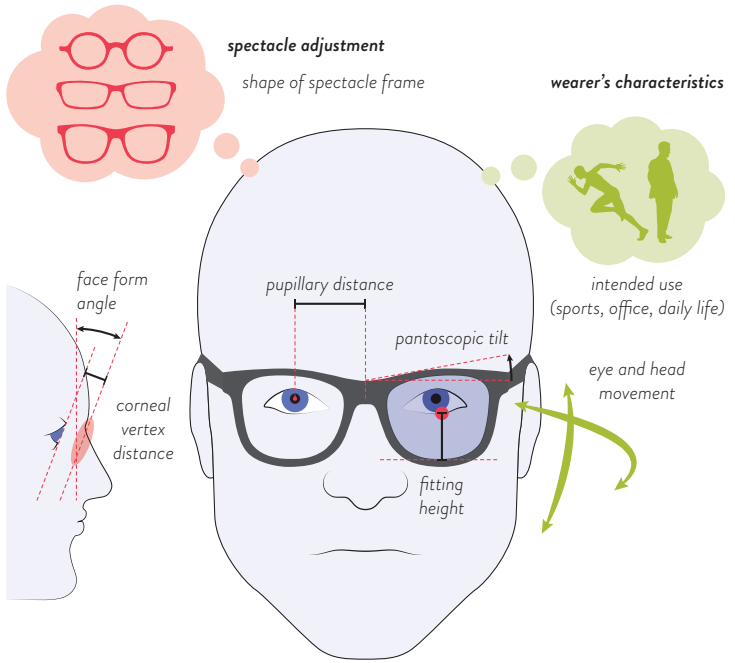

spherical: myopia or hyperopia

cylindrical: degree of astigmatism

prismatic: associated heterophoria

axial: direction of lens fitting

COMPUTER-CALCULATED LENS DESIGN

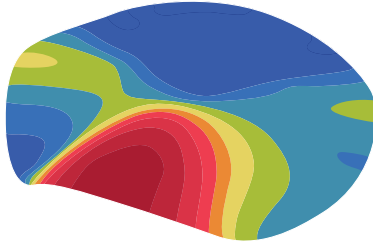

The different colors indicate the varying refractive power of the lens: from red (strong) to blue (weak).

MODEL OF VARIFOCALS

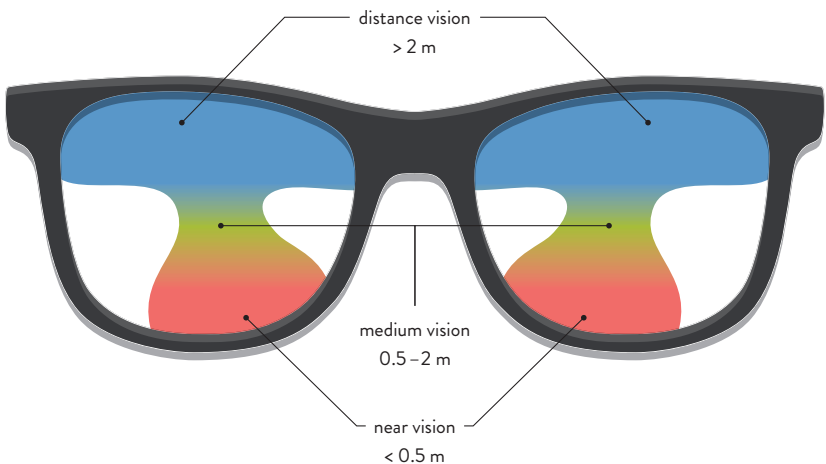

SEEING CLEARLY AGAIN

From the age of 60 onwards, most people get a slight cataract – known as the grey star. Treating cataracts is the most common operation around the world. The WHO estimates that by 2020, 32 million cataract operations will be performed. The use of the femtosecond laser with ultra-short pulses allows a precise and careful operation.

ANATOMY OF THE HUMAN EYE

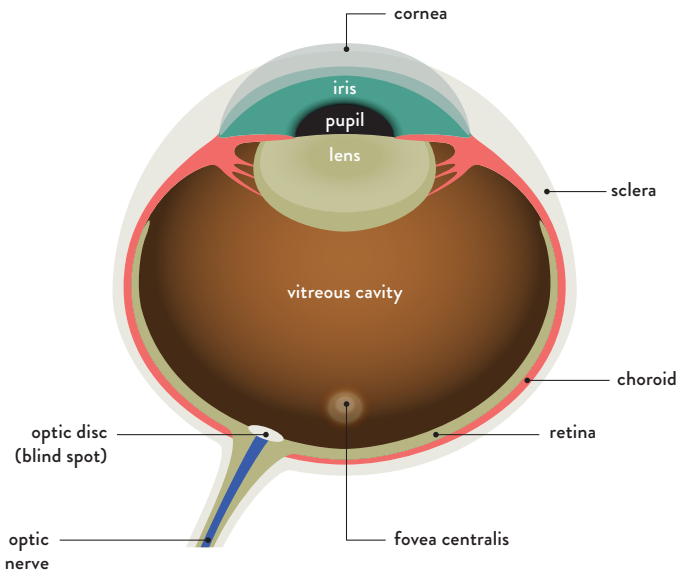

SEQUENCE OF A LASER OPERATION

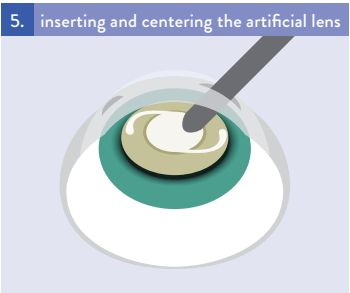
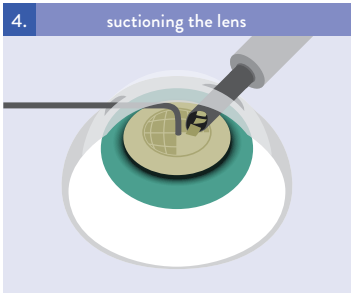
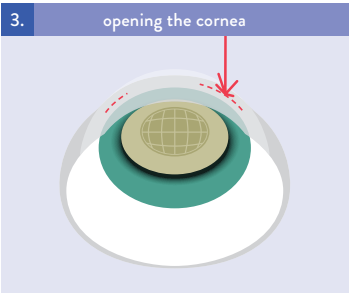
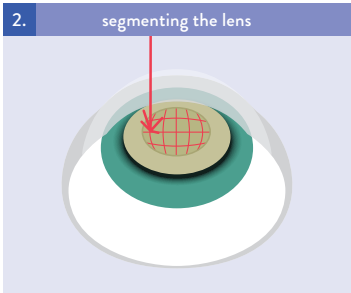
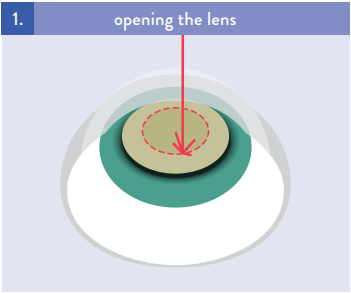



LIGHTING

WHITE LED LIGHT

LED chips make colorful light.
White light is created by luminescence conversion.

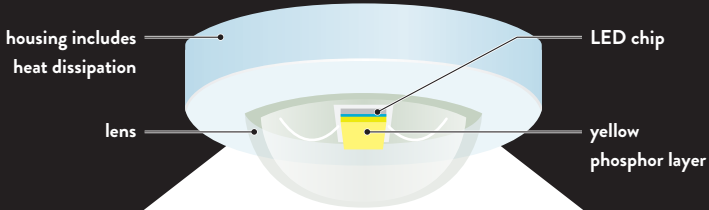

White light is a mix of red, blue and green.



Creation of white LED light through luminescence conversion:

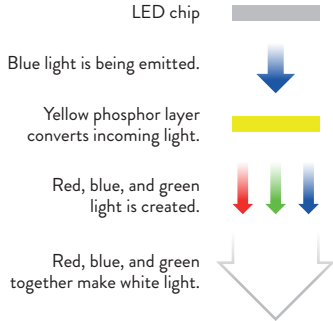

SPECTRUM OF A WHITE LED LAMP

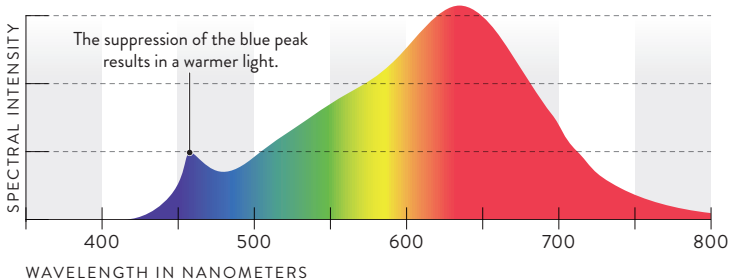

BRIGHTER WITH LED_s

Since the light bulb, the light output of different types of lamps has been significantly increased. Today, white LEDs are the most efficient ones.

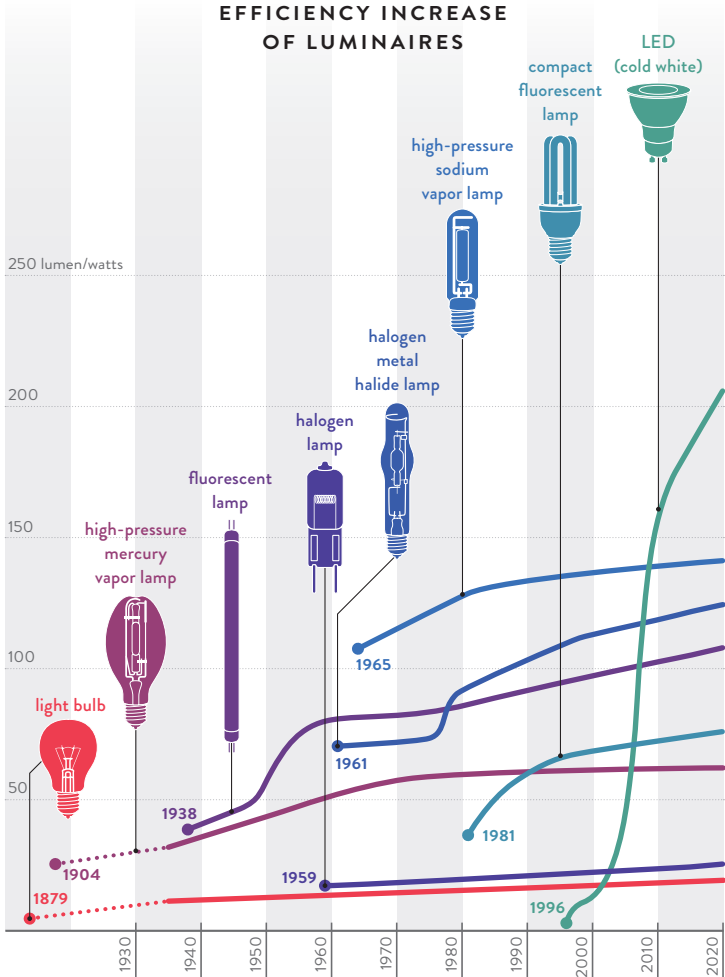

LAMP SPECIFICATIONS

Just a few years ago, you could find out almost everything you needed to know about the light of a domestic lamp just by looking at the number of watts. Nowadays, nearly a dozen criteria have to be considered.



- 
power (watts)
 electrical connected load
- 
brightness (lumens)
 how bright the lamp's light is
- 
color temperature (Kelvin)
 the higher the color temperature, the colder (more blue) the light
- 
warm-up time
 the time it takes for the lamp to fully light up
- 
dimmability
 lamp dimmable or not
- 
shelf life
 usage in hours
- 
color rendering index
 accuracy of color rendering
- 
energy savings
 in comparison to the conventional light bulb
- 
mercury content
 environmentally friendly without mercury
- 
illumination angle
 the scope and range of effective light

INTELLIGENT LUMINAIRES

LED lights can be switched on and off so quickly that it is imperceptible to the human eye. In this way, hundreds of megabytes per second can be transmitted to a mobile optical receiver as an additional function apart from the lighting – completely without electrosmog or additional cables.

MUSEUMS



BUSES



AIRCRAFT CABINS



TRADE FAIR STANDS



LASER SHOWS

Laser shows are an impressive way of demonstrating how fascinating photonics can be.

BRILLIANT COLORS

Only lasers can make colors that are completely saturated.

GREEN ENTERTAINMENT TECHNOLOGY

The relatively low energy consumption ensures environmentally-friendly entertainment for large crowds.

AUDIENCE

ARTIFICIAL FOG

Fog makes the laser beam visible.





SINGLE BEAMS IN THE SKY

This is only possible with explicit authorization from the aviation safety authorities.

BRIGHT & HIGH CONTRAST

In comparison to a video, a laser image is focused at any distance.

LASER PROJECTOR

Two extremely fast-moving computer-controlled mirrors draw the laser image.

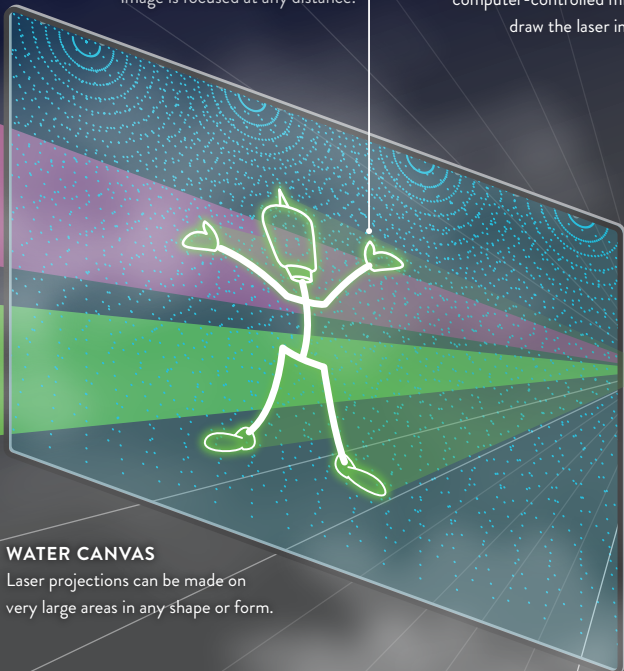

WATER CANVAS

Laser projections can be made on very large areas in any shape or form.



The background consists of several overlapping geometric shapes in two shades of teal. A large, light teal triangle points downwards from the top center. A darker teal shape, resembling a wide 'V' or a chevron, is positioned above the light teal triangle. The remaining areas are filled with solid dark teal. The word 'TRAFFIC' is centered in the light teal area.

TRAFFIC

TRAFFIC ENFORCEMENT

Measuring systems based on the roundtrip time of emitted and reflected infrared laser beams can calculate the speed of vehicles precisely. Cameras take pictures of the vehicle and driver if they have committed a traffic offence.

SPEED CAMERA COLUMN UNIT

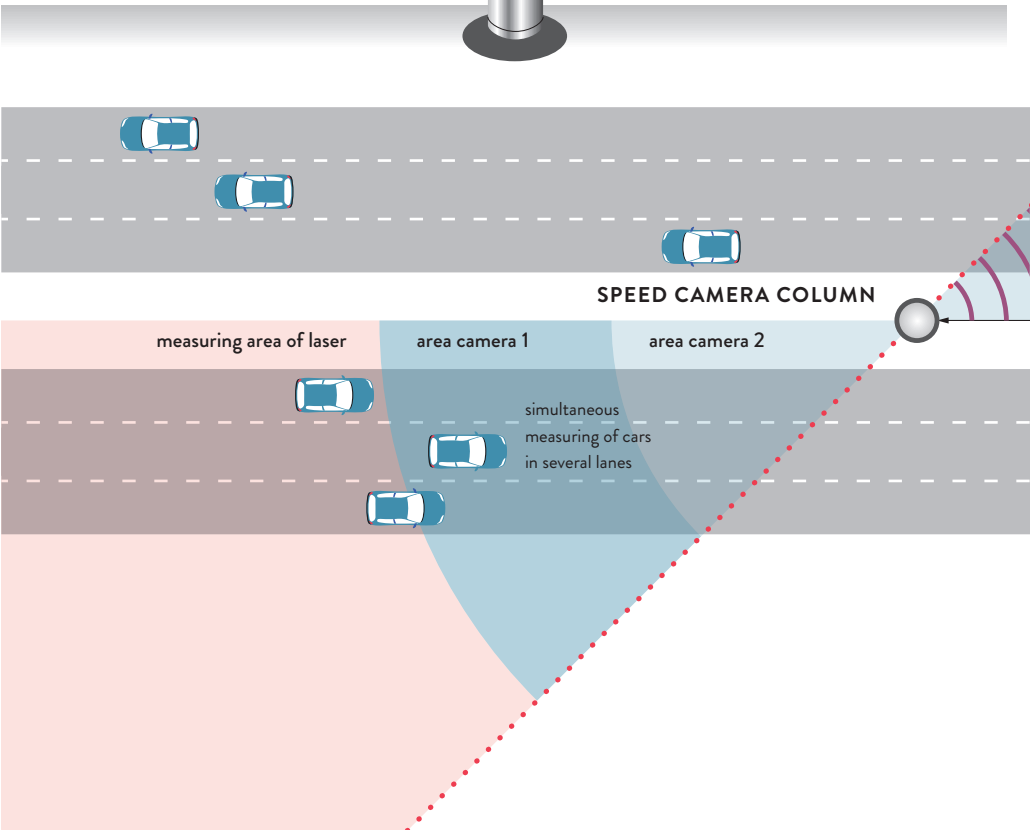
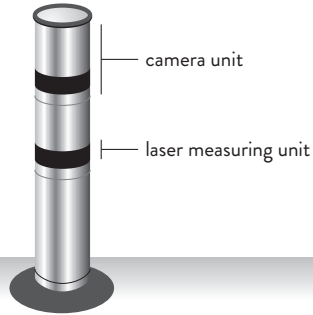



infrared laser light:
over 100 laser beams
100 times per second

Light impulses emitted from the speed camera column are reflected by the passing car and received again by the device.

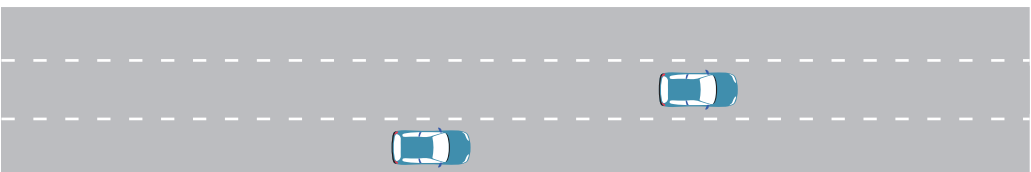
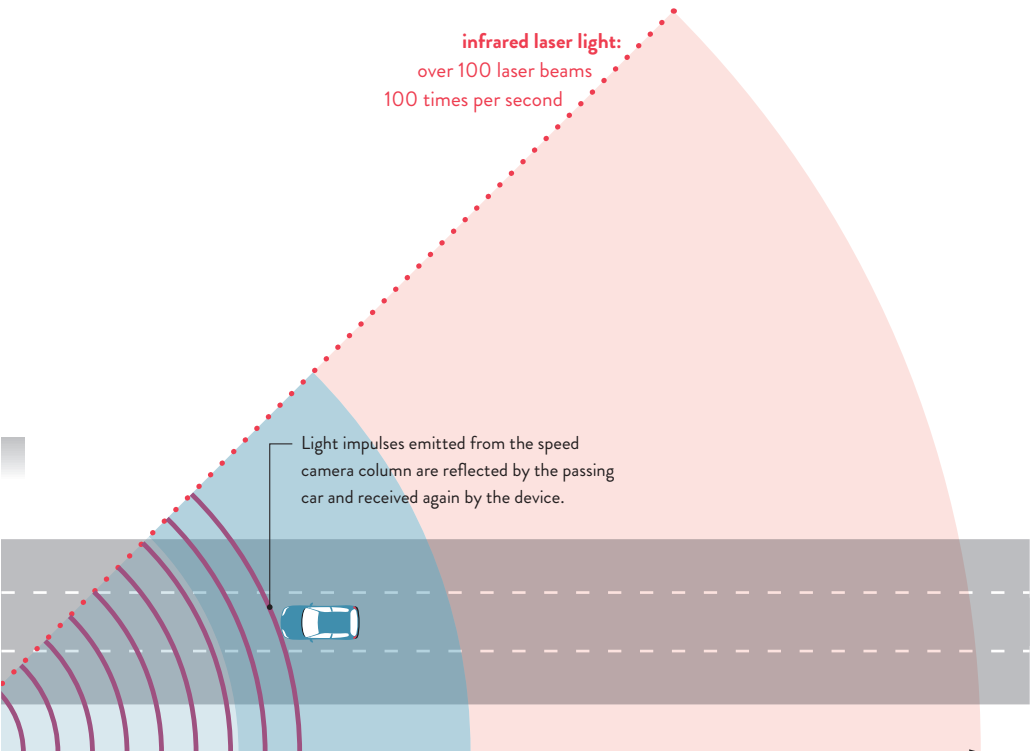

LIGHT ON AND IN THE CAR

Intelligent LED lights, camera-based assistance systems, and information displays ensure a greater security in all driving situations.

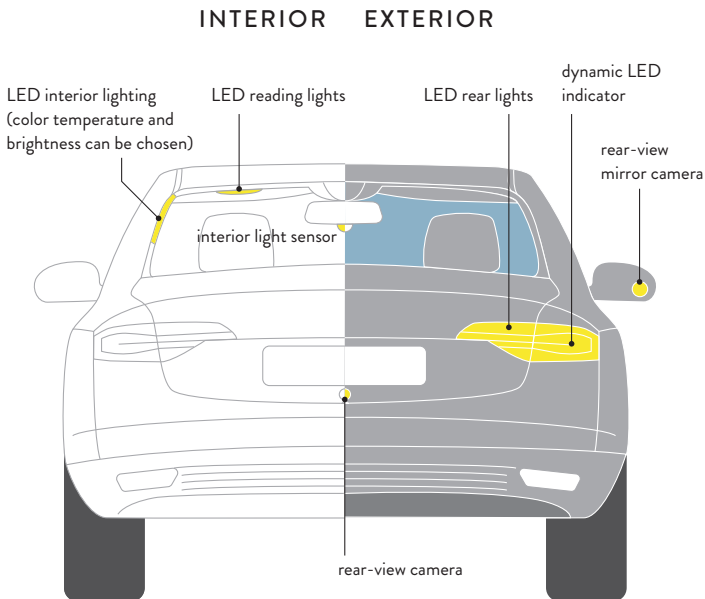

REAR VIEW



infotainment display



driver information display

EXTERIOR

INTERIOR

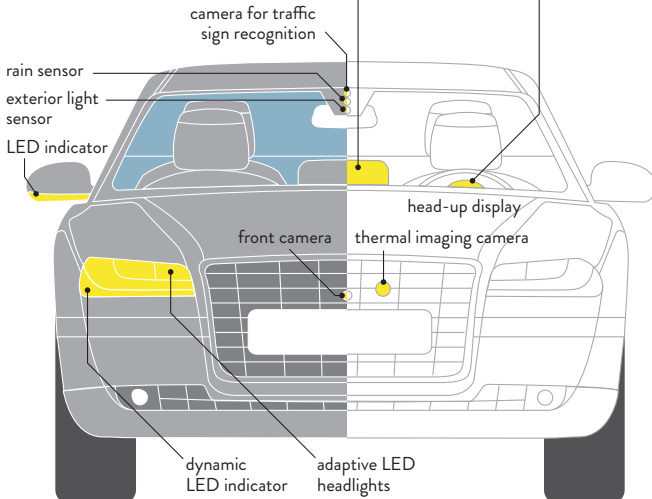

FRONT VIEW

CAR HEADLIGHTS

Seeing further ahead: the combination of LED and laser light sources enables an optimum for roadway illumination in every traffic situation.

LIGHT CONE OF HEADLIGHTS

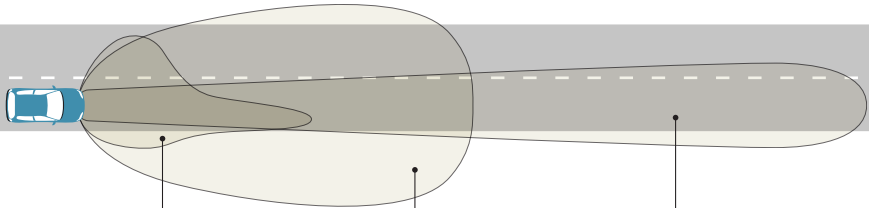

LED headlights

intelligent illumination to prevent glaring for oncoming traffic

LED high beams

large-scale illumination of the traffic situation

laser high beams

wide illumination for an optimal vision

LASER HIGH BEAMS

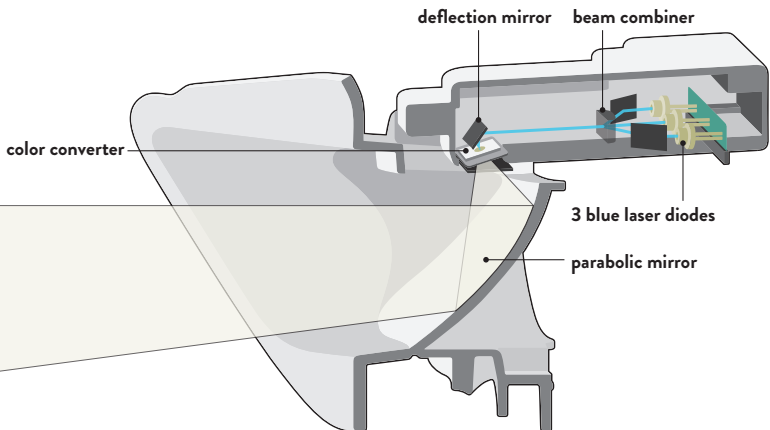

AIRPORT LIGHTING

Millions of new LED lamps lower the operation and maintenance costs of airports around the globe.

LED vs Halogen

hours shelf life	60,000	2,500
typical connected load per lamp (W)	18	65

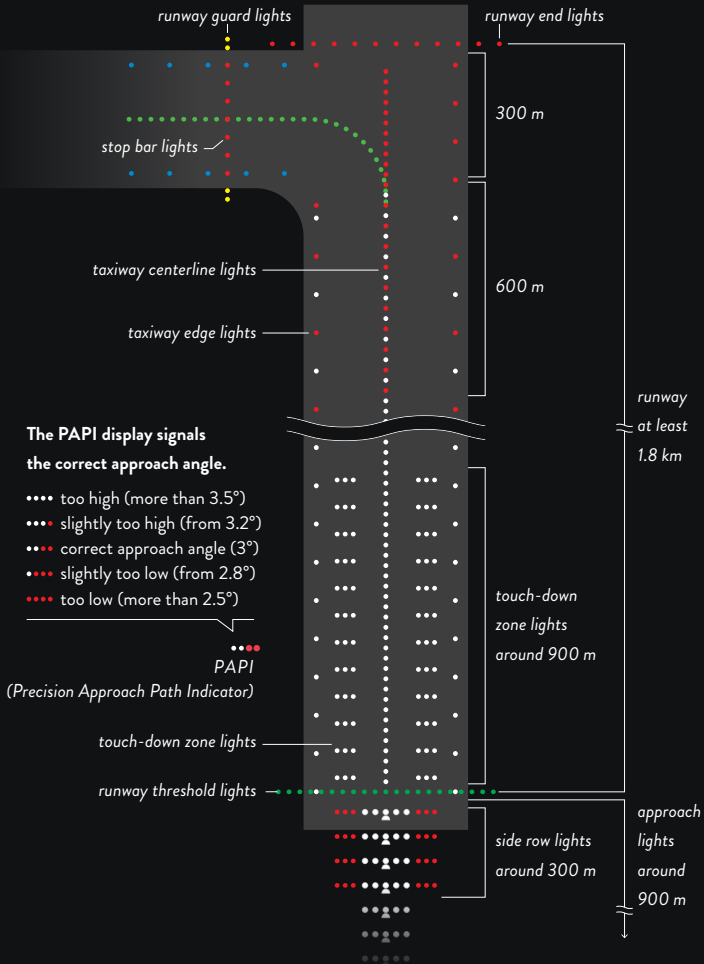

The background consists of several overlapping triangles in two shades of teal. A large, light teal triangle is centered and points downwards. It is surrounded by darker teal triangles that form a larger, more complex geometric pattern. The overall effect is a modern, minimalist design.

PHOTOVOLTAICS

SOLAR CELLS

Solar cells can transform sunlight directly into electricity. An efficiency of around 45% has already been achieved under laboratory conditions. In commercial use, efficiency has to be weighed against acquisition costs.

BASIC COMMERCIAL TYPES

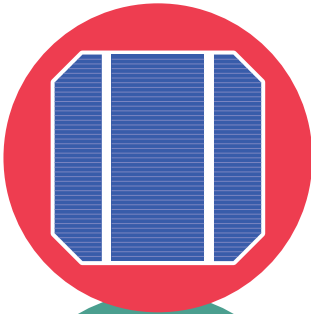

Monocrystalline silicon cells

are cut out from a round silicon crystal. The missing corners of the squares are characteristic. This form is created because the round cross section of the raw material is exploited in the best possible way.

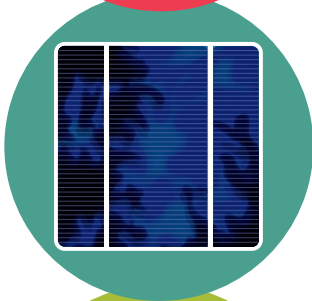

Polycrystalline silicon cells

feature a characteristic texture that comes from crystal borders that are very close together.

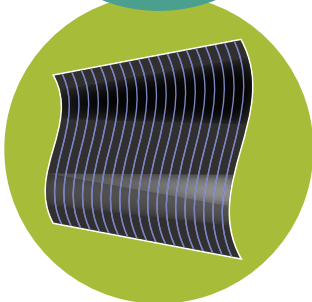

Thin-film cells

consist of amorphous silicone or other material compounds. They can be vapor deposited onto carrier materials, even onto flexible material.

GLOBAL MARKET SHARE

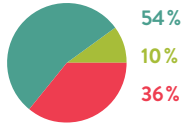

CHARACTERISTICS

monocrystallines

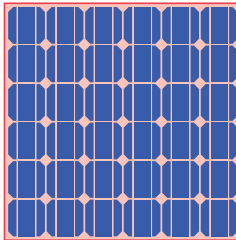

efficiency

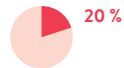

acquisition costs

polycrystalline

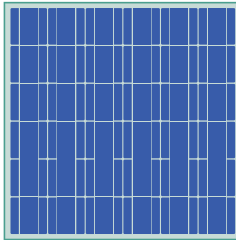

thin layer

amorphous
silicon



copper indium
diselenide

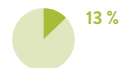

SOLAR ENERGY

Solar energy has the potential to satisfy the world's rising appetite for electricity without polluting the environment. What total size of solar power plants would be needed to run the United States on solar electricity?

US electricity consumption per year: 4093 TWh (2014)

Area of solar cells needed to supply this energy:
12,800 km²

*This roughly equals the land area of the
US state of Connecticut.*

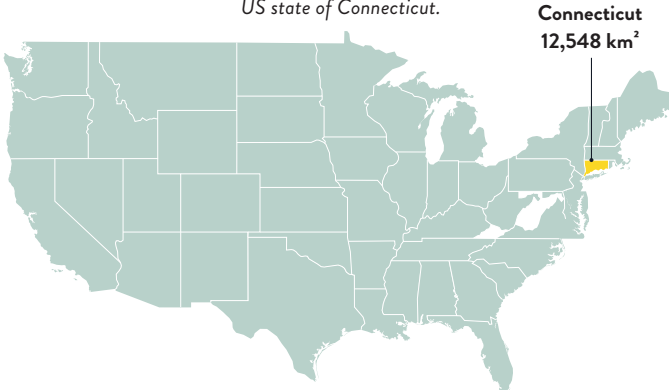

TOP PRODUCERS

installed power 2014 per capita in watts

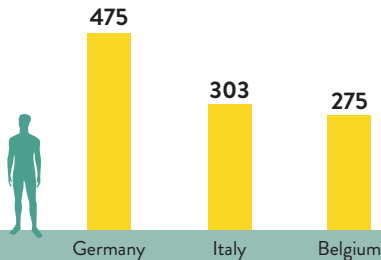

PRODUCTION COMPARISON 2014



World photovoltaic energy per year

180 Terawatt hours

= 180,000,000,000 kilowatt hours



Nuclear energy

The photovoltaic energy produced corresponds to the electricity volume of 20 nuclear power stations.



Crude oil

With regard to petroleum, the equivalent is 42 million tons. This amount corresponds to 140 oil tankers with a capacity of 300,000 GRT each.*

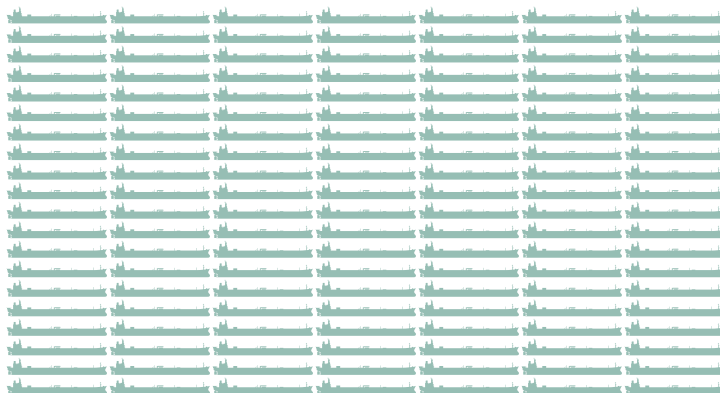

* gross register tons



ENVIRONMENT

OPTICAL MEASUREMENTS IN CITIZEN PROJECTS

Smartphones with attachable mini-spectrometers make it possible to map current environmental data of entire countries with the help of thousands of citizens.

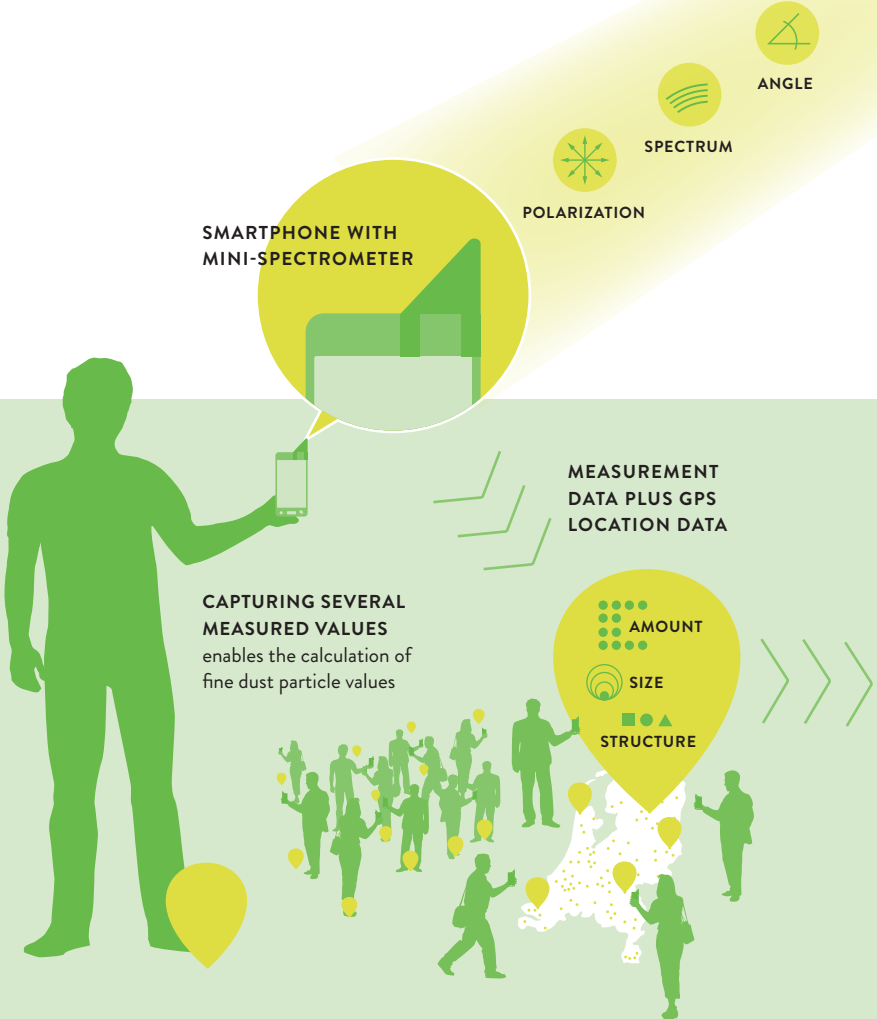



FINE DUST PARTICLES



FINE DUST PARTICLES
get into the air from
different sources

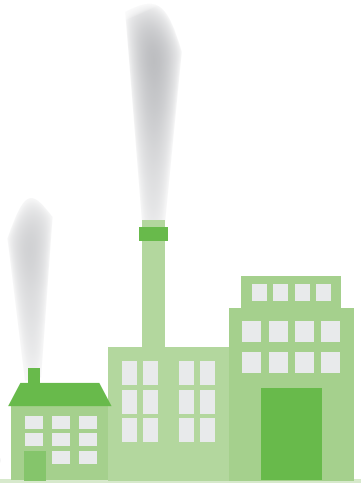

CENTRAL DATA EVALUATION
evaluation concerning the amount,
particle size, and composition

**MAPPED DATA THAT
IS ACCURATE IN TIME
AND LOCATION**

example: the Netherlands

POLLUTION



FOREST FIRE SURVEILLANCE

Automated optical sensor systems monitor large forest areas day and night for fires.

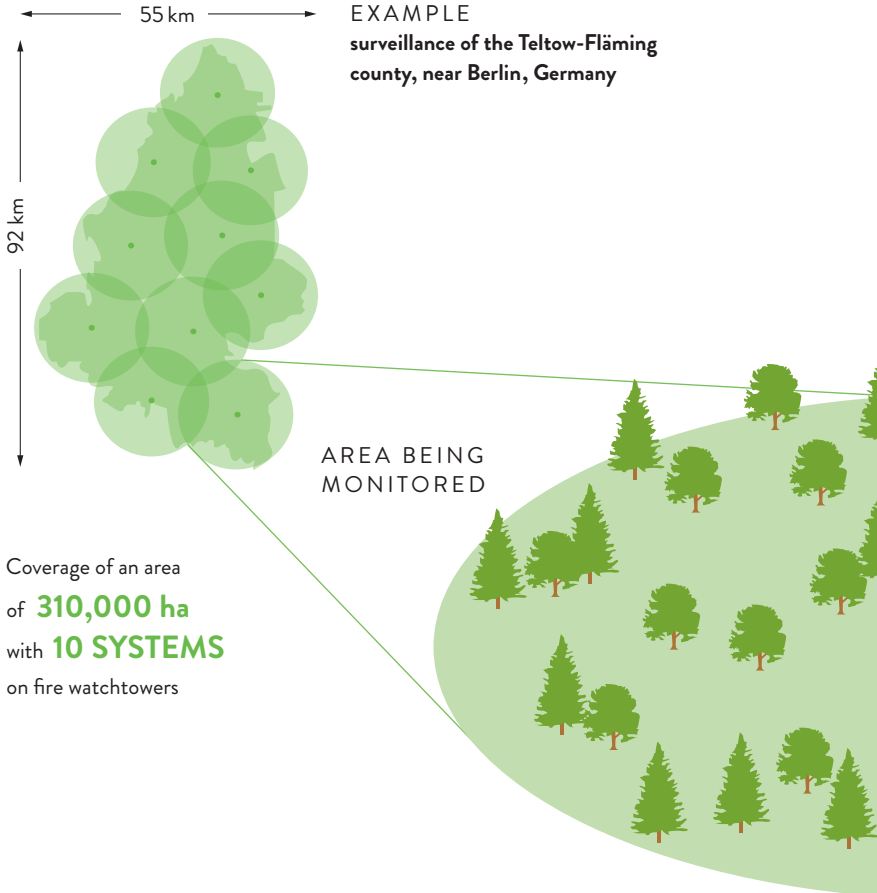

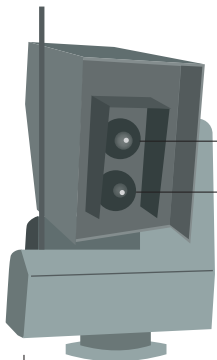

optics for night-time operation

optics for day-time operation

The optical sensor system registers smoke development automatically in the visible and infrared spectral range. The camera turns itself in stages on its own axis over 6 minutes.

OPTICAL SENSOR SYSTEM



FOREST FIRE ALARM CONTROL CENTER

receives data and images if a fire is detected



15 km

CAMERA ANGLE OF VISION
60° per minute

OPTICAL SORTING

Efficient sorting facilities are used to recover many materials in their raw form from heaps of domestic waste.

Together with fast image processing software, multispectral cameras capture within a split second what should be placed in which raw material container.

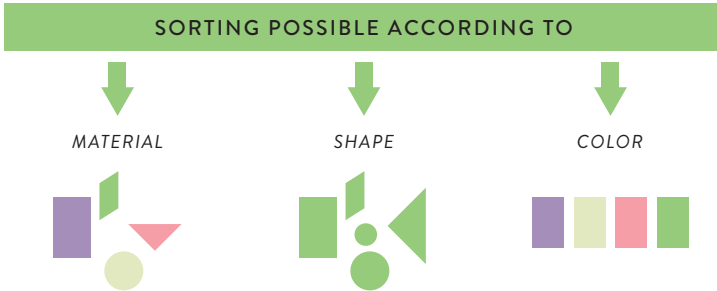

SCHEMATIC REPRESENTATION OF A WASTE-SORTING FACILITY

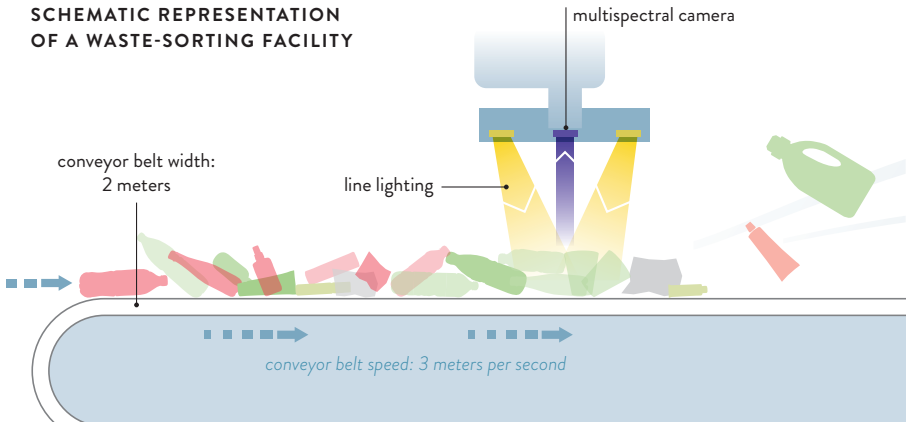

IDENTIFICATION OF MATERIALS

PAPER & CARDBOARD



PLASTIC CONTAINERS



IMPURITIES



OBJECT RECOGNITION AND VISUALIZATION OF BOTTLES

● PET ● PE ● PP ● PET+PVC ● PET+PP ● PET+PS

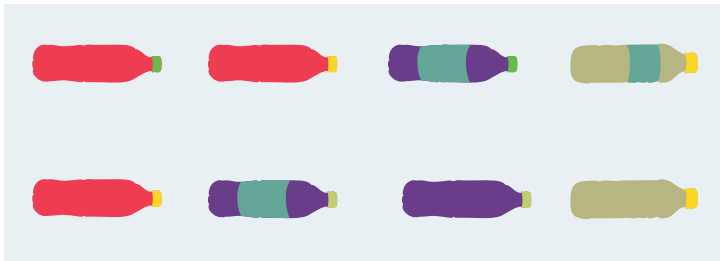

PE
polyethylene

PET
polyethylene terephthalate

PP
polypropylene

PS
polystyrene

PVC
polyvinyl chloride

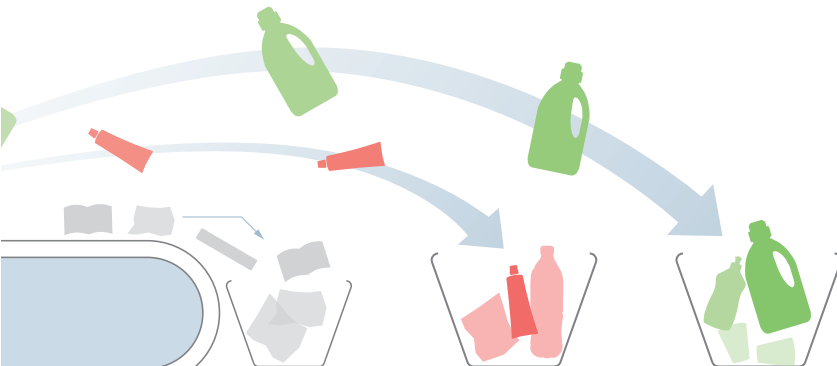



RESEARCH & ECONOMY

PHOTONICS AS AN INDUSTRY SECTOR

Within a few decades, the term photonics has developed from a technical term, used in research, to an industry term that encompasses all technical applications of light.



▶ from the 1960s

Photons are researched as an alternative to electrons for circuitry tasks. The term Photonics is coined in connection with this.

Invention of the laser

1960

1965

1970

1975

1980

1985

1990

Leading US industry magazine changes its name from Optical Spectra to Photonics Spectra

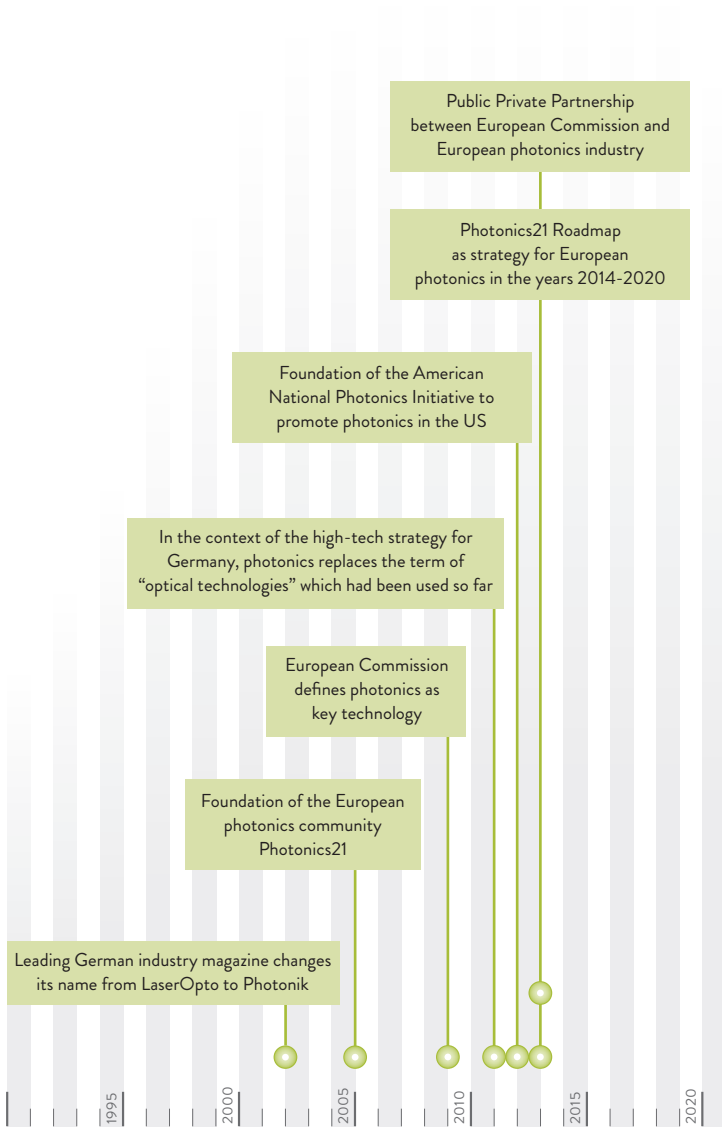

PHOTONICS AROUND THE GLOBE

Photonics is a global industry today. This graphic shows the strongest market segments in each region.

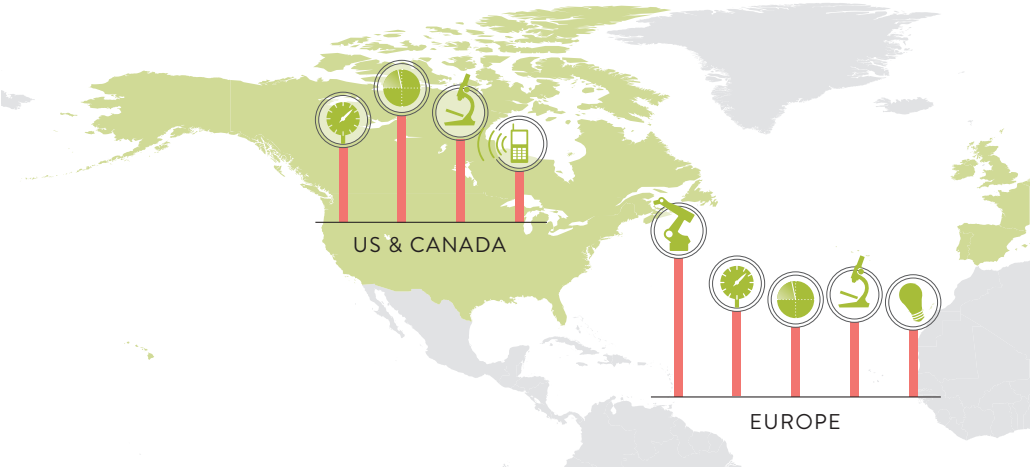

Global market share in the market segment (information in %)

To emphasize regional strengths, only market shares of more than 10% are shown.

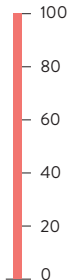

Market segments



production technology



image processing & metrology



security & defense technology

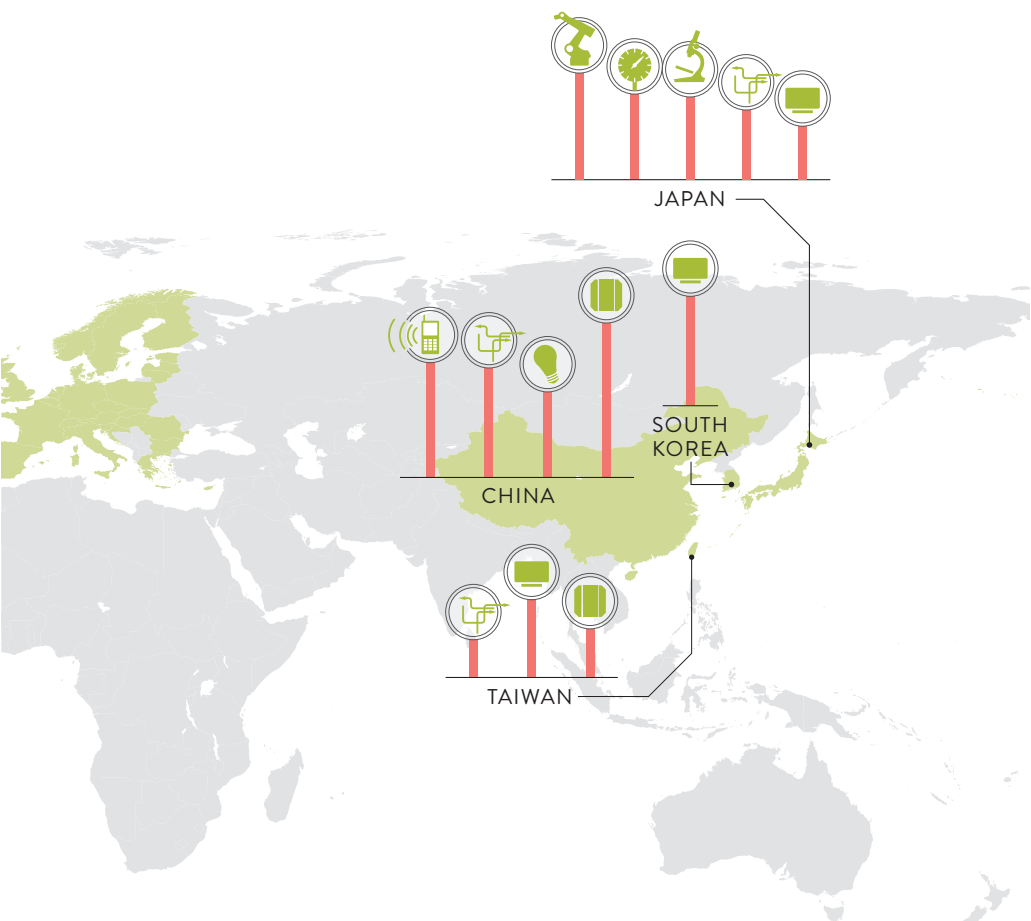

medical technology & life science



displays



communication technology



light sources



information technology



photovoltaics

NOBEL LAUREATES

Nobel laureates with a connection to photonics since the invention of the laser in 1960

NUMBER OF LAUREATES

by country at the time of the award ceremony

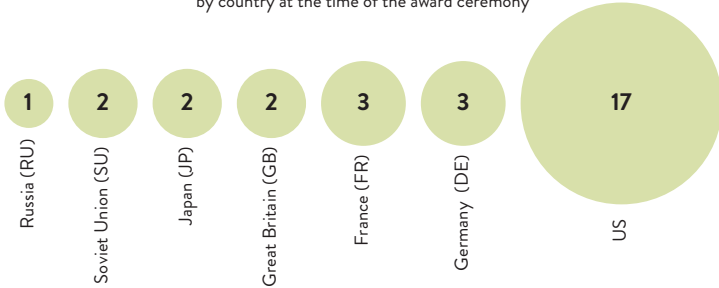

NOBEL LAUREATES

with award-winning research projects

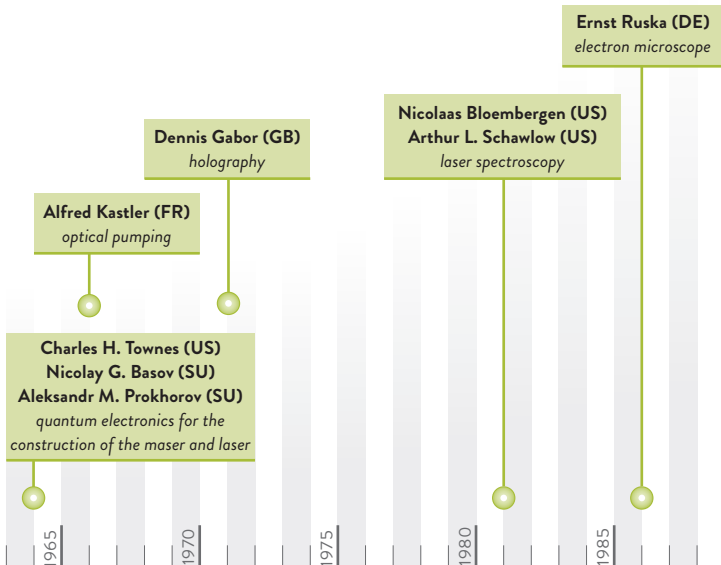

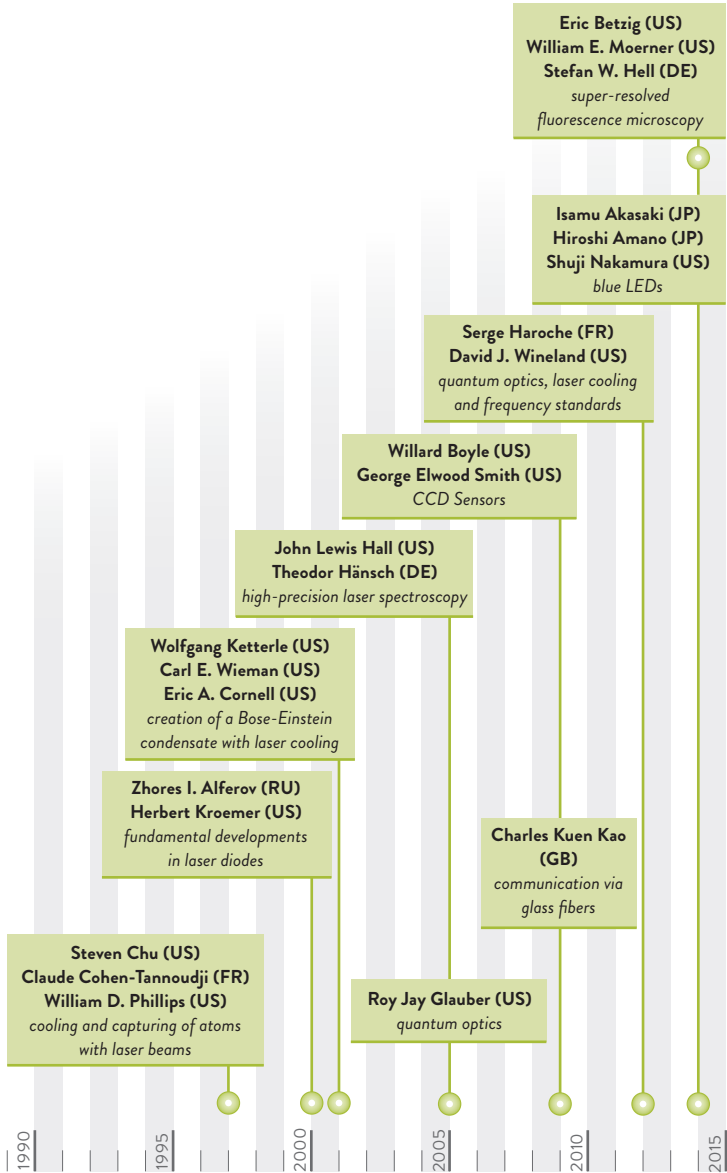

PHOTONICS COUNTRIES

The highest density of photonics professionals are found in Europe and East Asia.

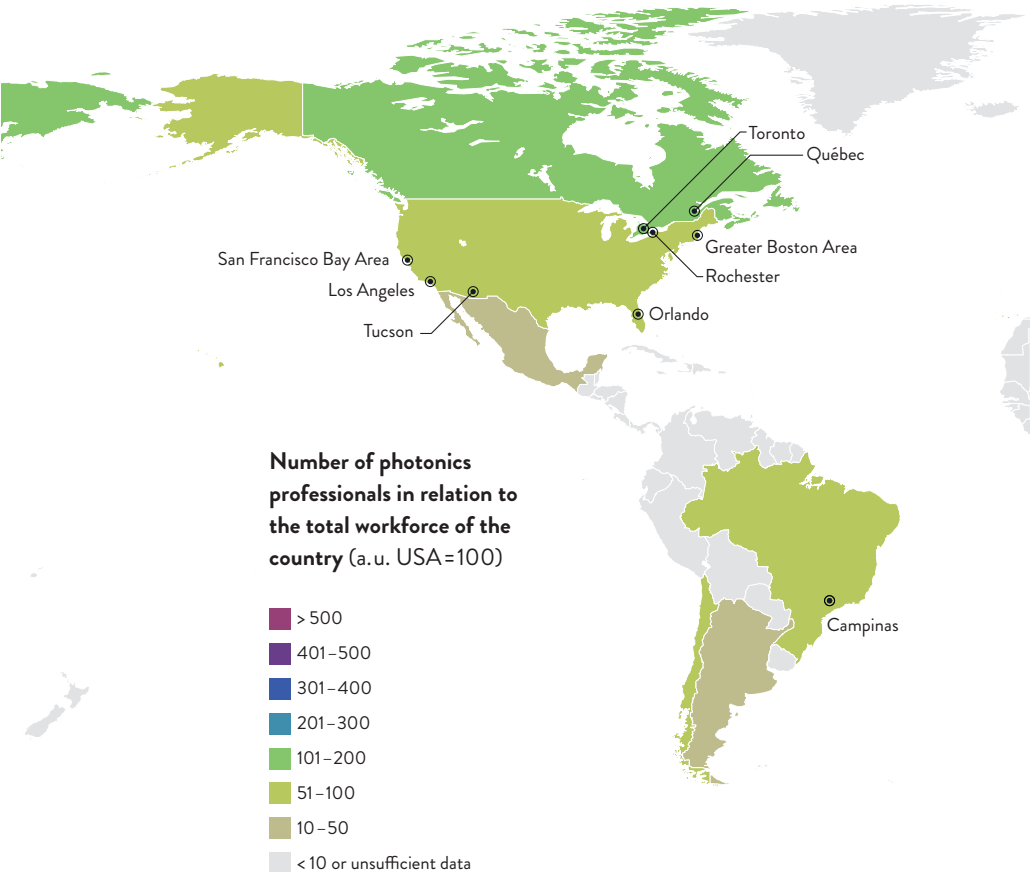

PHOTONICS SCHOOLS

Business-oriented social media reveal where photonics-savvy professionals got their education.

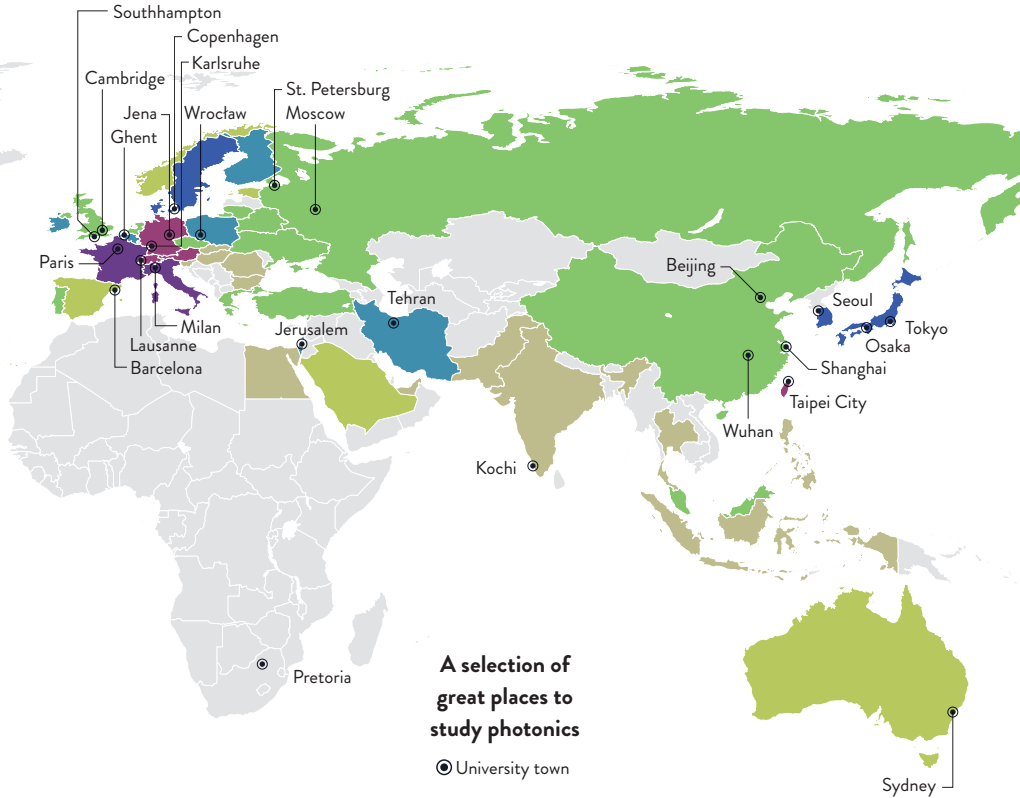

ECONOMIC IMPACT OF PHOTONICS

Data suggests that there were approximately 2.32 million jobs in photonics in 2015.

Worldwide photonics products market
in US-\$ bn.

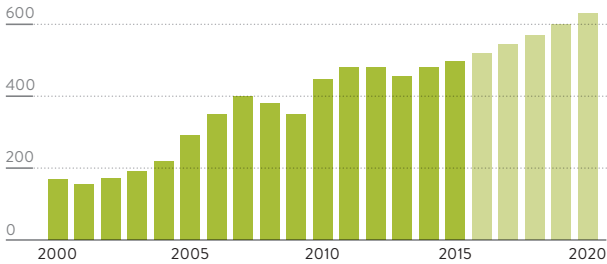

Photonics marketplace
from components to enabled services

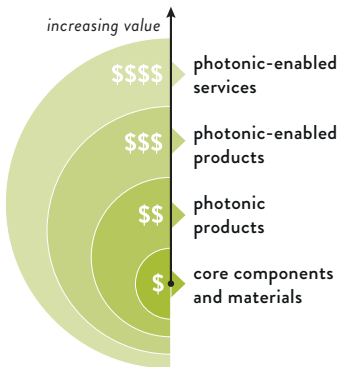

Market by country
share of market in %

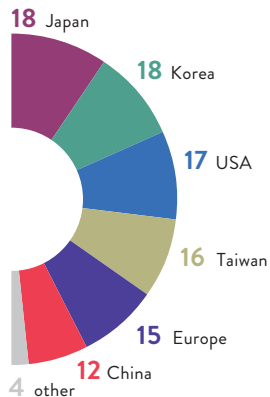

PHOTONICS ENTHUSIAST

An enthusiasm for photonics can also be implemented in the leisure sector.

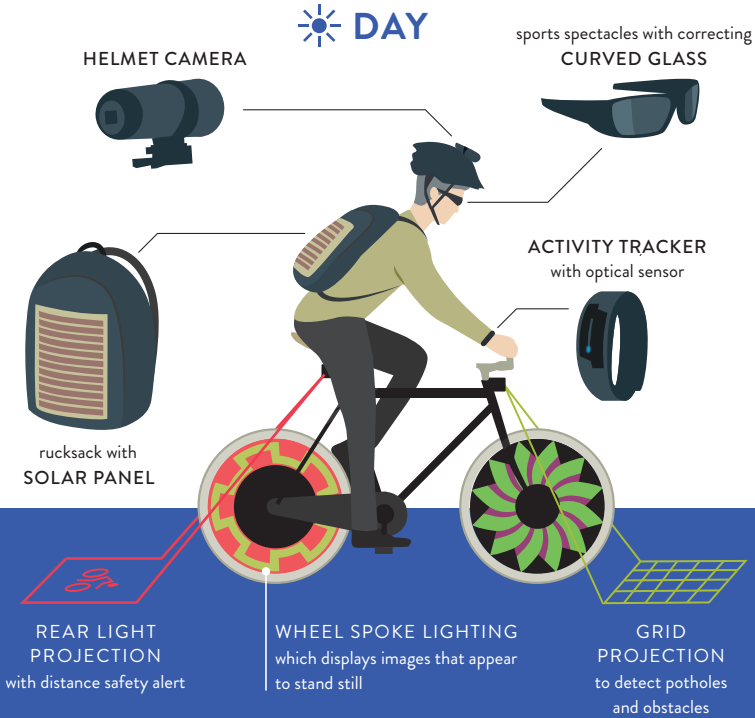

HIGH-VISIBILITY JACKET with LED direction indicators



NIGHT ☾

SOURCES

- 01 spectaris.de
- 02 Wikipedia
- 03 Wikipedia
- 04 Wikipedia
- 05 lbl.gov • bp.com/statisticalreview (2014)
- 06 Wikipedia
- 07 Wikipedia
- 08 photonics.com • spectaris.de
- 09 blu-raydisc.com
- 10 schott.com
- 11 edmundoptics.com
- 12 trumpf-laser.com
- 13 spectaris.de
- 14 zeiss.de
- 15 bosch.de
- 16 trumpf-laser.com
- 17 trumpf.de • rofin.de • coherent.com
- 18 ilt.fraunhofer.de
- 19 glasfaser.net • itwissen.info • telos.com
- 20 esa.eu
- 21 explainthatstuff.com
- 22 zeiss.de
- 23 hhi.fraunhofer.de
- 24 statista.com • Wikipedia
- 25 howstuffworks.com

- 26 flowcytometry.med.ualberta.ca/
- 27 karlstorz.com
- 28 spectaris.de · zeiss.de · optikum.at
- 29 northtorontoeyecare.com · techfak.uni-bielefeld.de
- 30 osram.com
- 31 osram.com
- 32 osram.com
- 33 hhi.fraunhofer.de
- 34 lobo.de
- 35 vitronic.com
- 36 audi.com
- 37 audi.com · bmw.com
- 38 frankfurt-airport.de · caeoxfordinteractive.com
- 39 solarbuzz.com
- 40 eia.gov · bp.com · spectaris.de
- 41 ispex.nl
- 42 fire-watch.de
- 43 lla.de
- 44 photonics21.org · spectaris.de
- 45 Spectaris, VDMA, ZVEI, BMBF: Photonics Industry Report 2013 · iea-pvps.org
- 46 nobelprize.org
- 47 linkedin.com · spectaris.de
- 48 linkedin.com · spectaris.de
- 49 spie.org
- 50 amazon.com · ebay.com

IMPRINT

SPECTARIS e.V.
German Hightech Industry Association
&
SPIE
International Society of Optics and Photonics

Editorial team:
Wenko Süptitz & Sophie Heimes,
SPECTARIS e.V.

Design:
Golden Section Graphics GmbH

Translation:
Claudia Eberlein

Editing:
Timothy Lamkins, SPIE

1st Edition 2016
Printed in U.S.A.

© 2016 SPECTARIS GmbH
All rights reserved.

ISBN: 978-3-9817205-1-8

